



REAPOR® | VITEROLITE® 900 | DECIDAMP® RTD

**Pyrotek**®



pyroteknc.com



---

## COMPANY PROFILE POLICIES

---

### 1 REAPOR®

Reapor® acoustic panels are high-performance noise absorbers that look like cut stone.

---

### 2 VITEROLITE® 900

Viterolite® 900 is ideally used in high wear, high impact and trafficable areas such as rail tunnels.

---

### 3 DECIDAMP® RTD

Decidamp® RTD is a high-performance engineered polymer composite vibration damper.

---

### 4 FIX8 ADHESIVE

Fix8 is a high quality adhesive recommended for Reapor and Viterolite® products.

---

### 5 CASE STUDIES | PROJECTS

Case studies relating to our products and project photos.

With ISO 9001 quality system certification, our global engineering team design highly specialised products to every specification and performance requirement. Our products are independently certified, time tested and supported by proven results.

## COMPANY PROFILE

**Pyrotek®** is a global engineering leader and innovator of performance-improving technical solutions, integrated systems design and consulting services for customers in the aluminium industry. We are also investing and growing rapidly in areas such as glass, noise control and advanced materials.

We have global resources and dependable local support in more than 35 countries with over 80 locations. Our products and solutions are in use around the world in automotive, aerospace, rail transportation and high-tech manufacturing.

Privately-owned since 1956, our deep-rooted values of integrity and collaborative problem-solving uphold our mission to improve customer performance.

### WHO WE ARE

- A global engineering innovator and supplier of complete end-to-end, performance improving technical solutions
- Our Noise Control division began in Australia, bringing over 30 years experience
- We supply complete turn-key solutions for many industries with over 300 Pyrotek application engineers, worldwide

### WHY CHOOSE US

- Strong R&D Laboratory Team - ceramic, acoustic & chemical engineers help maximise product performance
- Extensive data analysis and noise predictions
- Design capabilities using CAD and 3D modelling
- Global test laboratories for fire, acoustic and vibration

### OUR INDUSTRIES



Building



Industrial



Transportation



Marine



Oil & Gas



## SUSTAINABILITY POLICY

---

Pyrotek is committed to ethical corporate citizenship and to promote sustainability in its activities and environmental responsibility. We will treat the environment as a valued legacy for our grandchildren. While Pyrotek recognizes that its business activities have environmental and social implications, Pyrotek is committed to mitigate any environmental or social impact its business activities may have through the adoption of best practices and policies. Pyrotek will contribute to the development of a sustainable future through the following principles.

### PRINCIPLES

1. Practice responsible corporate conduct through adoption of workplace policies and best practices that meet or exceed regulatory and statutory requirements and that develop and maintain an entrepreneurial and collegial environment.
2. Manage risks, including those related to environmental, social and governance aspects.
3. Identify opportunities to contribute to the development of society and future generations.
4. Provide a safe, healthy and enriching working environment for Pyrotek employees.
5. Be a fair and responsible member of the communities in which Pyrotek operates.
6. As employees and as a company, be ethical and responsible citizens.
7. Be a responsible steward of resources.
8. Adhere to Pyrotek's Environmental Policy to limit its carbon footprint.
9. Pyrotek encourages the adoption of similar principles by its supply chain and business partners.



## ENVIRONMENTAL PRODUCT STATEMENT

---

### OUR COMMITMENT TO SAFETY, QUALITY AND ENVIRONMENT

Pyrotek is committed to safely produce quality products and services, on-time and at a competitive cost. This enables Pyrotek to build a sustainable business for the benefit of our customers, employees and stakeholders. Our focus is dedicated to developing systems with new, more considered operations and materials, as well as committing to improved technologies to further support long-term goals of safety, quality and environment.

#### Environmental Consideration

We acknowledge the need for consideration for our manufacturing activities to contribute to the mitigation of global warming via energy savings. We locally commit to reducing environmental impact by the prevention of pollution, minimization of waste and reduction of energy and water we use.

#### Ozone Depleting Potential

Pyrotek has undertaken an audit of its raw materials supplied and manufactured products barrier referencing to the US EPA List of Ozone Depleting Substances (Class 1 and Class 2). To the best of our knowledge, no ozone depleting substances are involved in either the manufacture or composition of these products.

#### Volatile Organic Compounds (VOC)

Products supplied by Pyrotek do not contain any significant Volatile Organic Compounds (VOCs) content when evaluated to the differing definitions as applied under the Australia National Pollutant Inventory, The Council of the European Union, Council Directive 1999/13/EC or the USA EPA Regulation 40 CFR 51.100(s). We also test to ASTM D5116 showing low VOC release.

#### Asbestos free manufacturing

Asbestos is not used during the manufacture of, and not added during any process of during the processing of our products. Please contact Pyrotek for available test reports to AS4964.

#### Global Warming Potential

Pyrotek's acoustic product range is designed with a reduced carbon footprint in mind, using locally sourced and environmentally-certified materials where possible. We use no CFCs, HCFCs or known high-GWP gases in our manufacturing process.

#### Recycle and emission care

During the process of manufacture, every care is taken to recycle and reuse material and where possible our plant and equipment has emission cleaners fitted.

## CODE OF BUSINESS ETHICS

---

### POLICY

This Code of Business Conduct and Ethics (the “Code”) represents the commitment of Pyrotek Inc. (which, together with all subsidiaries, is referred to as the “Company”) to conduct its business with integrity, in accordance with all applicable laws, rules and regulations and with high ethical standards. All employees, officers and general managers of the Company are expected to adhere to the principals and procedures set forth in the Code. However, no code can govern all possible situations. Therefore, those individuals governed by the Code must apply the spirit, as well as the letter, of this Code and request guidance from those identified below in the event of any question of interpretation. In all instances, each individual should strive to uphold the integrity and credibility of the Company. This Code is also supplemented by the rules of business conduct and ethics contained in the Company’s other policies and procedures.

*Note: This Code is subject to review and modification. The form of the Code made available on the Policies and Procedures Database of the Company supersedes any prior expression of the policy to the extent of any inconsistency. The following sections highlight key scenarios where the Code will govern individual behavior.*

### PROCEDURE

#### CONFLICT OF INTEREST

A “conflict of interest” occurs when an individual’s private interests interfere, or appears to interfere, in any way with the interests of the Company. A conflict of interest can arise when an employee, officer or director takes actions or has a personal or non-Company related business interest that may make it difficult to perform his or her Company work objectively and effectively. Conflicts of interest also arise when an employee, officer or director, or a member of his or her family, receives improper personal benefits as a result of his or her position in the Company. Loans to or guarantees of obligations of such persons are of special concern as conflicts of interest. Service to the Company should never be subordinated to personal gain and advantage.

All conflicts of interest as described above are prohibited. Each employee, officer and director should be careful to avoid a conflict of interest by avoiding actions or relationships that may either make it difficult to perform Company work objectively and effectively or affect personal judgment regarding what is in the Company’s best interest.

Any individual who has any questions or concerns regarding this policy, or any specific situations, actions or omissions which may relate to or be prohibited by this policy, is encouraged to discuss such questions or concerns with any of the following individuals: the Company’s (1) President, (2) Chief Financial Officer or (3) Corporate Counsel.

#### CORPORATE OBLIGATION

Employees, officers and general managers owe a duty to the Company to advance its legitimate interests when the opportunity to do so arises. Each employee, officer and director is prohibited from:

1. Taking for themselves personal opportunities that are discovered through the use of Company property, information or position;
2. Using Company property, information or position for personal gain; or
3. Competing with the Company.



## **CONFIDENTIALITY**

Employees, officers and general managers should maintain the confidentiality of confidential and proprietary information entrusted to them by the Company and its guests and customers, except when disclosure is authorized or legally mandated. Confidential information includes all nonpublic information that might be of use to competitors of the Company, or harmful to the Company or its guests or customers if disclosed.

Employees, officers and general managers are encouraged to consult the CFO, prior to making any disclosure, with any questions regarding whether a legal obligation to disclose confidential information exists. The obligation to maintain confidentiality extends indefinitely after a person's association with the Company as an employee, officer and director has ended.

## **FAIR DEALINGS**

Each employee, officer and director should endeavor to deal fairly with the Company's customers, suppliers, competitors and employees. No employee, officer or director should take unfair advantage of anyone through manipulation, concealment, abuse of privileged information, misrepresentation of material facts or any other unfair dealing practice. Nothing contained in this paragraph shall in any way alter any existing legal rights and obligations of the Company or its employees, officers or general managers.

## **PROTECTION AND PROPER USE OF COMPANY ASSETS**

Company employees, officers and general managers should protect the Company's assets and ensure their efficient use. Each employee, officer and director should endeavor to prevent misuse, loss, damage, sabotage or theft of Company assets. All Company assets should be used for legitimate business purposes only.

## **COMPLIANCE WITH LAWS, RULES AND REGULATIONS; REPORTING ILLEGAL OR UNETHICAL BEHAVIOR**

The Company is committed to complying with all laws, rules and regulations applicable to it, including, but not limited to, those impacting the obligation of the Company to present all financial information to the public in conformance with generally accepted accounting principles based upon information which accurately reflects all relevant facts.

## **COMPLIANCE AND REPORTING**

Employees, officers and general managers should strive to identify and raise potential issues before they lead to problems, and should ask about application of this Code whenever in doubt. Any employee, officer or general manager who becomes aware of any existing or potential violation of this Code should promptly notify the individual responsible for enforcement identified in the Section entitled "Policies and Procedures for Interpretation and Enforcement of the Code".

## **POLICIES AND PROCEDURES FOR INTERPRETATION AND ENFORCEMENT OF THE CODE**

The President, General Counsel and Chief Financial Officer are responsible for applying this Code to specific situations relating to violations of the Code by general managers and executive officers and to specific situations relating to violations of the Code by other employees which have a material adverse effect on the Company's overall operations or financial position.

Company management will handle violations of the Code by individuals other than general managers or executive officers in the same manner that other violations of Company policies are handled and it is expected that most violations occurring in the ordinary course of the Company's business will not be sufficiently material to require report to the Shareholders of the Company or the President.

## **WAIVERS**

From time to time, the Company may waive certain provisions of this Code. Any employee, officer or general manager who believes that a waiver may be appropriate should discuss the matter with the President.



# 1 | REAPOR®



Reapor® is constructed from small aerated granules made from recycled glass. The granules are fused together through a patented high temperature sintering process to form a hard, **lightweight**, fibre-free, **non-combustible** stone-like panel that can be used indoors and outdoors. The unique material is highly porous, absorbing noise both between and within the granules.

# REAPOR®

**Reapor®** panels are simple and easy to install using recommended adhesives (refer to the Reapor® Installation Guide for details). The panels can be cut, drilled and routed using standard wood working tools, enabling easy installation around obstacles.

The panels are suitable for use outdoors. Wet panels will drain freely and dry in the sun.

*Reapor® is a registered trademark of Liaver used with permission by Pyrotek as distributors.*

## Features

- Non-combustible
- Lightweight and fibre free
- Easy to cut, drill and rout using standard wood working tools
- Resistant to weather, water and UV exposure over an extended period of time
- Natural 'stone-like' appearance to suit indoor and outdoor designs

## Application

- Rail and motorway tunnels, vent shafts and noise barriers
- Industrial noise enclosures
- Plant rooms or elevator shafts
- Exhaust stack internal lining



Standard size: 25 x 625 x 625 mm 25 x 625 x 1200 mm 50 x 625 x 625 mm 50 x 625 x 1250 mm
Custom sizes available depending on MOQ, including 65 mm thick Reapor®. 25 mm thick Reapor® does not feature chamfered edges.

## VOC STATEMENT

Reapor® does not contain any Volatile Organic Compounds (VOC) when evaluated to the differing definitions as applied under the Australia National Pollutant Inventory, the EU Council Directive 1999/13/EC or the USA EPA Regulation 40CFR 51.100(s). This product can be classed as low VOC-emitting. The material emissions are less than the threshold of 0.5 mg/m<sup>2</sup>/hr as specified in Green Building Council of Australia 'Green Star' credit IEQ-13. Formaldehyde compound emission rate is less than the threshold of 0.1 mg/m<sup>2</sup>/hr as specified in 'Green Star' credit IEQ-14.

## REAPOR® TECHNICAL DETAILS

No.	Property	Method	Specification
1	Density	-	Maximum density 300 kg/m <sup>3</sup>
2	Electrical conductivity	"AS/NZS 3000 (tested with 5kV insulation tester)"	Non-conductive
3	Service life \ Design life	--	Documentation asserting a minimum design life of 30 years
4	Acoustic performance	ISO 354, ISO 11654	"Requires a minimum $\alpha_w = 0.90$ (at 50 mm thickness)"
5	Non-combustibility	AS 1530.1 / ISO 1182	Shall be deemed non-combustible
6	Flammability testing – Cone calorimeter	AS 5637.1	Minimum Group 1 rating
7	Flammability testing & smoke density – fire tests on building materials	AS1530.3	Ignitability, 0
			Spread of flame, 0
			Heat evolved, 0
			Some developed, $\leq 1$
8	Compressive strength	DIN 196-1	> 1 MPa
9	Flexural strength	DIN 196-1	> 0.35 MPa
10	Tensile strength	DIN 1607	> 0.1 MPa
11	Thermal conductivity	DIN 52612	< 0.09 W/mK
12	Non-hazardous material	Classification according to EU Regulation EC 1272/2008 (GHS)	All materials shall be classified as not being Hazardous
13	Volatile organic compound (VOC)	ASTM D5116	Total VOC < 0.5 mg/m <sup>2</sup> /hr
14	Ozone depleting potential (ODP)	--	Zero ODP, no materials with ODP added, used or generated during manufacture

# TECHNICAL DATA SHEET



# REAPOR®

## eco-friendly sound absorber for challenging environments

Reapor® acoustic panels are high-performance noise absorbers that look like cut stone.

It is constructed from small aerated granules made from recycled glass. The granules are fused together through a patented high-temperature sintering process to form a hard, lightweight, fibre-free, non-combustible stone-like panel that can be used indoors and outdoors. The unique material is highly porous, absorbing noise both between and within the granules.

Reapor® panels are simple and easy to install using recommended adhesives (refer to the Reapor® Installation Guide for details). The panels can be cut, drilled and routed using standard woodworking tools, enabling easy installation around obstacles.

The panels are suitable for use outdoors. Wet panels will drain freely and dry in the sun; however, this may result in efflorescence where crystalline salts are deposited on the surface of the panel. Efflorescence will not affect acoustic performance. If efflorescence does occur, the salts may be removed using commercial efflorescence cleaners. *(Please refer to the Reapor® Installation Guide for more information).*

### VOC STATEMENT

Reapor® does not contain any Volatile Organic Compounds (VOC) when evaluated to the differing definitions as applied under the Australia National Pollutant Inventory, the EU Council Directive 1999/13/EC or the USA EPA Regulation 40CFR 51.100(s). This product can be classed as low VOC-emitting. The material emissions are less than the threshold of 0.5 mg/m<sup>2</sup>/hr as specified in Green Building Council of Australia 'Green Star' credit IEQ-13. Formaldehyde compound emission rate is less than the threshold of 0.1 mg/m<sup>2</sup>/hr as specified in 'Green Star' credit IEQ-14.

### SPECIFICATIONS

Colour	Light grey
Available	50 x 625 x 625 mm 50 x 625 x 1250 mm
	25 x 625 x 625 mm 25 x 625 x 1200 mm 63 x 625 x 625 mm <i>(25 mm and 63 mm sold FCL only)</i>
	Custom sizes available depending on MOQ

*25 mm thick Reapor® does not feature chamfered edges.*

*Reapor® is a registered trademark of Liaver used with permission for Pyrotek as distributors.*



## applications

- Rail and motorway tunnels, vent shafts and noise barriers
- Outdoor cafes, bars and restaurants
- Interior walls and ceilings of offices, retail spaces, hospitals, schools and aged care facilities
- Fire exits and stairwells
- HVAC and genset plant rooms
- Industrial noise enclosures
- Shooting ranges

## features

- Resists weather, water and UV exposure over an extended period
- Non-combustible
- Exceptionally high NRC of 0.95 (50 mm thick panel)
- Easy to cut, drill and rout using standard woodworking tools
- Natural 'stone-like' appearance to suit indoor and outdoor designs
- Made from recycled glass
- Lightweight
- Fibre free



**PRODUCT SPECIFICATIONS**

Product name	Thickness (mm)	Panel size			Density (kg/m <sup>3</sup> )
		Length (mm)	Width (mm)	Approximate weight (kg)	
Reapor® 25/625625	25	625	625	2.6	270
Reapor® 25/1200625		1200		5.1	
Reapor® 50/625625	50	625		5.3	
Reapor® 50/1250625		1250		10.5	
Reapor® 63/625625	63	625		6.6	

Tolerances: Dimensions  $\pm 1$  mm, Density:  $\pm 10\%$ . 25 mm thick Reapor® does not feature chamfered edges.

**MATERIAL PROPERTIES**

Test method	Property	Report	Results	
DIN 196-1	Compressive strength	B 12.16.103.01	1.46 N/mm <sup>2</sup> ( $\pm 10\%$ )	
	Flexural strength		0.53 N/mm <sup>2</sup> ( $\pm 10\%$ )	
DIN 1607	Tensile strength		0.14 N/mm <sup>2</sup> ( $\pm 10\%$ )	
DIN 1048	Dynamic modulus of elasticity		833 N/mm <sup>2</sup> ( $\pm 10\%$ )	
DIN 52612	Thermal conductivity	1254P41/P	0.077 W/mK	
AS/NZS 3000	Electrical conductivity	9765	Non-conductive	
EN 13501-1	Fire classification of construction products and building materials	KB 3.1/11-121-3	Non-combustible	
DIN 4102	Fire resistance	16-900 9171 002-1		
AS 1530.1 / ISO 1182	Fire resistance	FNC11639		
AS 1530.3	Method for fire tests on building materials, components and structures	16-000832	Ignitability	0
			Spread of flame	0
			Heat evolved	0
			Smoke developed	1
ISO 5660 / AS/NZS 3837	Building code compliance	FH 5357-01-2	NCC	1
			NZBC	1-5
ASTM D5116	Total volatile organic compound emission rate	CV130829	0.026 mg/m <sup>2</sup> /hr	
	Formaldehyde compound emission rate		<0.005 mg/m <sup>2</sup> /hr	
EN 1793-1	Intrinsic sound absorption performance of roadside noise reducing devices	P-BA 235/2020	DL <sub>a</sub> 11 dB Category A3	
Pyrotek Pull Test Method	Adhesion of Reapor to concrete substrate using recommended fixing methods and adhesive	13121BDA	> 3.7 kN/m <sup>2</sup> (> 380 kgf/m <sup>2</sup> )	

## ACOUSTIC PERFORMANCE

Frequency (Hz)	Reapor 25 mm	Reapor 50 mm	Reapor 63 mm
100	0.04	0.08	0.16
125	0.06	0.10	0.23
160	0.08	0.29	0.38
200	0.13	0.37	0.53
250	0.13	0.57	0.81
315	0.23	0.92	1.02
400	0.35	1.12	1.13
500	0.52	1.23	1.13
630	0.67	1.21	1.07
800	0.90	1.02	0.97
1000	1.05	0.98	0.92
1250	1.13	1.03	0.98
1600	1.05	1.09	1.04
2000	0.97	1.08	1.02
2500	0.93	1.04	1.03
3150	0.98	1.05	1.01
4000	0.99	1.04	1.08
5000	0.94	1.04	0.95
NRC	0.65	0.95	0.95
SAA	0.67	0.97	0.97
$\alpha_w$	0.45 (MH)	0.90	1.00

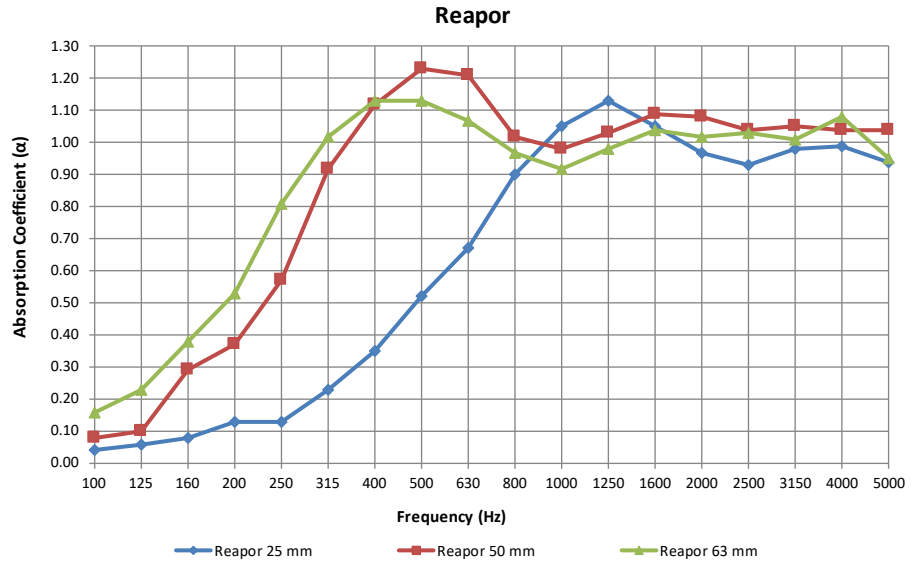

Tested to ISO 354:2003 at Vienna Experimental and Research Institute (Austria) & CSIRO (Australia)  
 Report Numbers: MA 39-VFA 2007-1277.01, AC186-01-1 & P-BA 195/2017e

For further information and contact details, please visit our website [pyroteknc.com](http://pyroteknc.com)

*Caveats: Specifications are subject to change without notice. The data in this document is typical of average values based on tests by independent laboratories or by the manufacturer and are indicative only. Materials must be tested under intended service conditions to determine their suitability for purpose. The conclusions drawn from acoustic test results are as interpreted by qualified independent testing authorities. Nothing here releases the purchaser/user from responsibility to determine the suitability of the product for their project needs. Always seek the opinion of your acoustic, mechanical and fire engineer on data presented by the manufacturer. Due to the wide variety of individual projects, Pyrotek is not responsible for differing outcomes from using their products. Pyrotek disclaims any liability for damages or consequential loss as a result of reliance solely on the information presented. No warranty is made that the use of this information or of the products, processes or equipment to which this Information Page refers will not infringe any third party's patents or rights. DISCLAIMER: This document is covered by Pyrotek standard Disclaimer, Warranty and © Copyright clauses. See [pyroteknc.com/disclaimer](http://pyroteknc.com/disclaimer).*



# INSTALLATION GUIDE





## REAPOR®

This installation guide provides recommendations to maximise the service life of Reapor® applications.

### KEY INSTALLATION REQUIREMENTS

Reapor® panels are simple and easy to install using recommended brackets and adhesives. The panels can be cut, drilled and routed using standard woodworking tools, to enable easy installation around obstructions.

All substrates must be clean and free from laitance, curing compounds, dirt, dust, grease, oil and any other contaminants that may inhibit bond.

Reapor should be installed on dry walls and ceilings. Panels are not recommended for installation on retaining walls or below damp courses.

To prevent rainwater migration to the rear of the panels in outdoor applications, the panels should be installed with either flashing/capping installed over the top panels/wall (eg. COLORBOND® steel) or panels can be recessed into the pre-cast concrete walls. The recommended recess is 70 to 80 mm (2.8 to 3.1 in) to cater for the panel, adhesive layer and ~25 mm (1 in) soffit/drip edge above the top acoustic panel.

The bottom panels should be installed with a free drip edge to enable Reapor to drain freely and avoid wicking water up from pavements etc.

Reapor® is quickly and easily installed to horizontal and vertical surfaces.

### TUNNEL APPLICATION

To ensure a smoother installation for tunnel applications, we recommend using 625 x 208 mm panels.



### applications

- Interior walls and ceilings of offices, retail space, hospitals, schools and aged care facilities
- Walls of railway and motorway tunnels, vent shafts and exits
- Applications requiring high fire ratings
- Airports, stations, and carparks
- Machinery or industrial enclosures
- HVAC, plant rooms, and substations
- Exit ways, smoking areas, stairwells and drive-through areas
- Road barriers, exterior plant fences and sound barriers

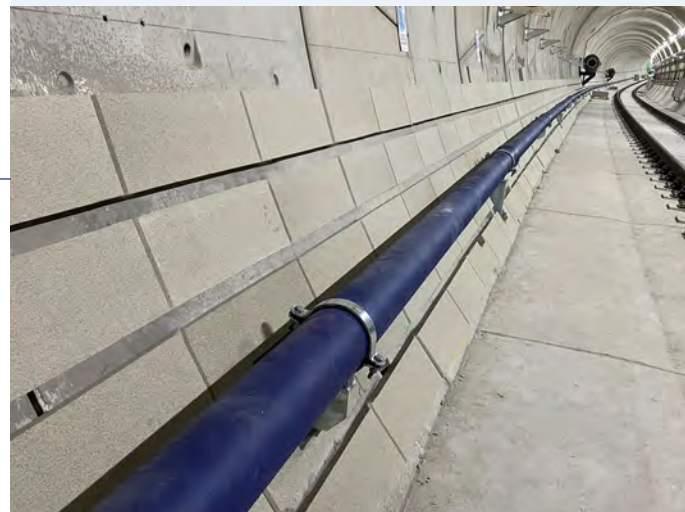

Reapor 625 x 208 panels installed in tunnel application

Reapor® is a registered trademark of Liaver used with permission for Pyrotek as distributors.



## INSTALLATION USING ADHESIVE AND MECHANICAL FIXING

### CONCEALED FIXING

1. Approved Pyrotek adhesive (Fixseal MS15, Fix8, Pyrogrip PU) should be used to fix RB brackets (see RB bracket drawings below) and Reapor panels to rigid substrates, such as concrete, pre-fabricated walls, block work, timber, reinforced fibre cement boards or sheet metal.
2. When applying to solid surfaces (cementitious products) a Ramset / Hilti or equivalent gun with 25 mm stainless steel drive pins / nails can be used to fix RB Brackets only.
3. All substrates must be clean and free from laitance, curing compounds, dirt, dust, grease, oil and any other contaminants that may inhibit bond.
4. All substrates should be washed with clean water and thoroughly dry before the application of the adhesive.
5. If in doubt, prepare the substrate using a pressure washer to expose the fine aggregates in the matrix of the concrete as this ensures a clean substrate.
6. Consideration should be given to the transfer of load on horizontal installation - panels must not bridge expansion joints
7. Use a straight edge support to ensure a level plane is set for the RB Base Brackets.
8. Apply 3 grams of adhesive to each RB Base Bracket and secure in place allowing the straight edge to support brackets during curing process. Allow adhesive to cure for 2-3 hours before proceeding with Reapor installation.  
Alternatively secure each bracket with 25 mm stainless steel drive pins / nails (cementitious substrates only)
9. Two RB Base Brackets are required for each Reapor panel. Each bracket should be a minimum of 90 mm from each panel edge - allowing for minimum 325 mm centre space between the brackets of each panel.
10. Apply 3 grams of adhesive to upward facing base of fixed bracket before placement of Reapor panel - this will ensure better adhesion.
11. **For 625 x 625 panels** apply adhesive to outer edge of panel (6 x 9 grams per blob) - ensure glue is approx 100 mm from the edges (see image 1).
12. **For 625 x 208 panels** apply adhesive to outer side of panel (2 x 8 grams per blob) - ensure glue is approx 100 mm from the edges (see image 2).
13. Slightly angle tile to substrate with lower back edge resting on RB Base Bracket (see image 3). Secure in place pushing firmly against substrate.
14. Apply 3 grams of adhesive to back and base of RB Spacer bracket, Center bracket or Top bracket and secure to top edge of panels (two brackets for each panel) - ensure adhesive is applied between bracket and panel (see image 4).
15. Secure bracket in place by pressing into Reapor panel and gently hammering in place with small rubber mallet.
16. Each Reapor tile should be pierced with a total of four spikes - two along the lower edge and two along the upper edge.
17. Stains or debris on the surface of Reapor® can be removed by lightly sanding.
18. Refer to Mechanically Fixing drawing for flat surfaces (below) for installation instructions using RB Brackets.

1



Apply adhesive around the edges of the tile only

2



Apply adhesive to the side of the tile only (625 x 208 panels)

3



Apply the tile to the substrate with firm pressure

4



RB Centre Bracket with adhesive applied



## RB BRACKET DRAWINGS (brackets made from 316 stainless steel)

### Mechanical fixing using RB Centre Brackets

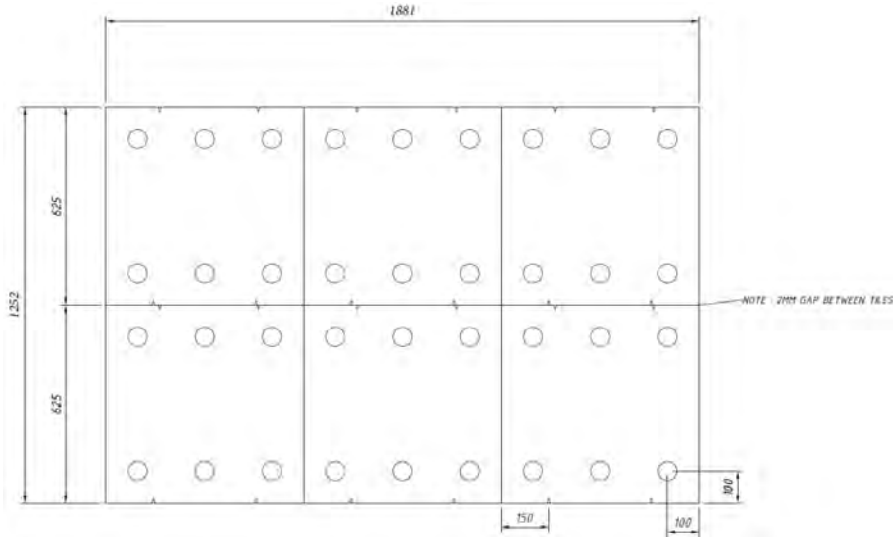

1

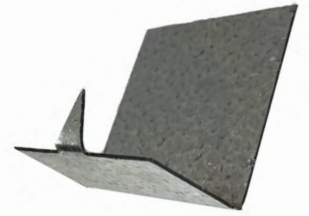

RB Base Bracket

2



RB Spacer Bracket

### Mechanical fixing using RB Spacer Brackets

(Example of Installation for tunnels and curved surfaces)

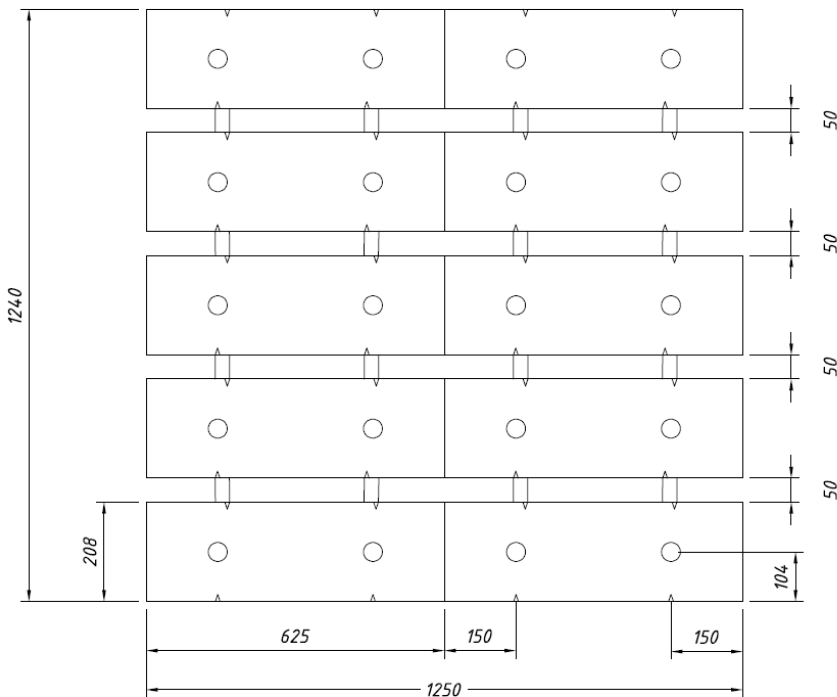

3

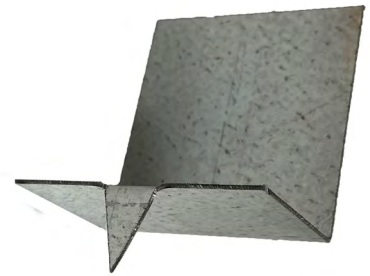

RB Top Bracket

4

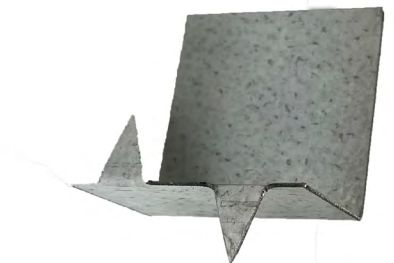

RB Centre Bracket

Reapor Brackets are supplied in stainless steel.  
Minimum order quantities apply

KEY	
	ADHESIVE
	RB SPACER BRACKET
	RB BASE BRACKET
	RB TOP BRACKET
	RB CENTRE BRACKET



## INSTALLATION USING ADHESIVE AND MECHANICAL FIXING cont.

### UNCONCEALED FIXING

***This method is recommended for high wind load and elevated areas***

*For unconcealed mechanical fixing - stainless steel or plastic pins (UV resistant) can be used.*

1. Follow mechanical fixing steps as above for recommended adhesive and Reapor installation guide.
2. Once panel has been applied to substrate, drill through the centre of the panel and approx 30 mm into the substrate using an 8 mm drill bit (see image 1).
3. Insert 8 mm x 80 mm pin into pre-drilled hole (see image 2).
4. Use a hammer to gently tap the pin into the substrate (see image 3)
5. Ensure the pin is flush with Reapor surface (see image 4)
6. It is recommended to paint pin heads after installation to prevent corrosion and UV oxidation caused by the elements.

*This installation section is for general advice only.*

*If you feel your application is unique please contact your Pyrotek representative for more information.*

1



*Drill into the centre of Reapor*

2



*Gently insert pin*

3



*Gently hammer the pin in place*

4

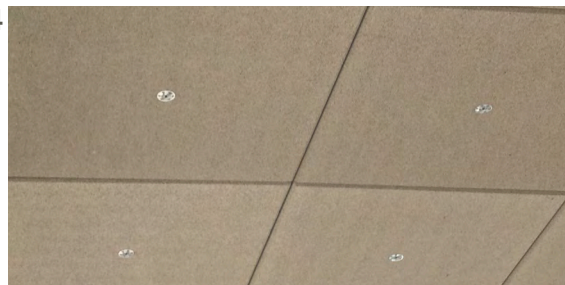

*Completed overhead installation*

## GENERAL MAINTENANCE

### Weathering

Reapor® is a porous stone-like material with a consistent colour and texture through the tile. Reapor® will weather and age naturally in the elements in a similar way to soft natural stones.

In outdoor applications, Reapor® may show signs of efflorescence, a temporary condition which can be removed by brushing or rinsing with a hose. In most cases, over time rainwater steadily removes the deposit leaving the original colour of the panel unharmed.

Ensure adequate drainage is present so that efflorescence deposits do not occur as a result of pooled runoff water.

Efflorescence does not affect the quality, acoustic performance or functionality of Reapor®.

### Care, Repair and Maintenance

- Replace any cracked or broken tiles.
- Clean any debris to maintain the free drip edge and ensure the damp course is not breached.
- Regularly inspect flashing to ensure it remains functional.
- Clean off any efflorescence by first dry brushing off build up of deposits with brush or tools. The surface can also be sanded to remove surface stains or other marks (you can use a piece of Reapor® as a sanding block - ie Reapor on Reapor).
- If further staining is visible, consider hosing down, or using mild soapy water to rinse. Efflorescence remover is recommended only for very stubborn areas.

## DETAILING

### Cutting, Routing and Rebating

Reapor® tiles can be easily processed, routed, rebated or hand sawn to any shape such as creating grooves and channels.

- A circular saw fitted with a continuous rim diamond tipped masonry blade can be used for cutting in large projects.
- Consideration should always be made for proper dust control and ensure suitable PPE is equipped before work.

*(Please refer to the Reapor® SDS for further information)*

### Treatment of Perforations

Adequate flashing should be incorporated to discourage and deflect water away when Reapor® tiles are drilled for cabling and pipe access



Reapor resists weather, water and UV exposure



Tunnel application - Reapor installed on the wall



Regularly inspect flashing for functionality



Reapor can be routed to allow cable access

Please contact Pyrotek® for further information or detailed advice on your specific application.

# HANDLING GUIDE



## REAPOR TRANSHIPPING AND HANDLING GUIDE

*This guide is designed to give advice and direction for the devanning of containers and general transshipping and storage of Reapor acoustic tiles. This is a general guide only and all normal health and safety procedures should be followed, and site conditions considered to complete a thorough risk assessment.*

**The Recipient agrees to strictly follow and observe all manufacturer instructions and a failure to strictly store or handle the goods as directed may lead to personal injury, death and/or property damage, including damage to the goods. Pyrotek disclaims and excludes all liability for claims caused by the Recipient not strictly following the manufacturer's recommended storage and handling procedures.**

**\*\*BEFORE INSTALLING PLEASE BE AWARE THAT REAPOR IS FRAGILE.  
HANDLE WITH CARE TO AVOID DAMAGE.**



### Shipping Containers

Reapor is shipped around the world in 20 or 40' containers. It is packed with extreme care and airbags are used to secure the load to prevent movement and transit damage.

The container will have airbags at the front that need to be released as well as side airbags to prevent transit movement, simply puncture to release the air.



### Unpacking a container

1. To remove the pallets, use either a forklift ramp and container forklift and adjust the tines, to accommodate the narrower pallet base.
2. If a container forklift and ramp are not available use a European pallet jack to move each pallet to the edge of the container, then fork lift out. The standard pallet jack is too wide for the pallets which are stacked end on.



## Lifting the Reapor pallet

1. When adjusting the tines on the forklift to accommodate the narrow pallets, make sure the tine is not over the fitting notch as this can cause the pallet to topple.
2. The product is packed on pallets which are not rigid. Avoid sudden bumps or dropping of the pallet as this may cause the bottom tiles to crack.
3. Lift from the end until out of container. Then lift sideways across slats to ensure a stable load.



## Handling palletised Reapor

1. Lift sideways with tines across slats.
2. Tilt tines back and tie/strap panels to mast to ensure the tiles don't topple over when moving.
3. Handle with care and avoid impact.
4. Avoid sudden drops when moving via forklift.
5. Avoid bumps when travelling with pallets on forklift.
6. Keep area around forklift clear, suggest
  - a. 3m exclusion zone. Spotter should remain clear of the forklift, at a safe distance.
7. Move only with forklift or pallet jack.



## Unpacking Reapor pallets.

1. Pallet should be placed in a safe location prior to unpacking, clear of other Reapor pallets, visual obstructions or hazards.
2. Inspect for damaged or cracked tiles prior to unpacking. Additional care may be needed for pallets containing damaged tiles.
3. Use elevated platform to access Reapor tiles, unloading one tile at a time, from top first.
4. Care should be taken as to not scrape or scratch surface of Reapor when unloading.

## Storage

1. Do not stack pallets on top of each other or stack anything on top.
2. Protect from any mechanical damage (Bumps or knocks).
3. Make sure pallets are stored on level ground, placed gently down not shunted into place with tines of forklift.
4. Pallets should be covered to prevent moisture ingress.
5. When covered ensure also adequate ventilation of the covering to prevent sweating and condensation build up.

## Packaging

Each pallet is 1.30 m x 1.11 m x 2.37 m (Length x Width x Height)

The weight of each pallet will be approx. 775 kgs.





# SERVICE LIFE





**MAHAFFEY ASSOCIATES PTY LTD**

(ABN 90 001 629 036)

Incorporating BEMAC Laboratories

Unit 9 / 108-110 Percival Road (P O Box 2162), Smithfield NSW 2164

Ph (02) 9756 4003

Fax (02) 9757 4228

Email mahaffey@mahaffey.com.au

*BAS/17/L02/10929*

6 July 2017

Pyrotek Pty. Ltd.

147 Magowar Road

**GIRRAWEE NSW 2145**

Attention: Bruce Hermes

Dear Sir,

**Re: Service life Assessment of Reapor**

**1. Background**

The report covers a review the Reapor panels with the view of providing durability and the service life assessment. The Reapor was developed about 20 years in Germany and the panels have been installed the manufacturer's site since then. In Australia, it has been installed in the Clem Jones Tunnel (North-South Bypass Tunnel) in Brisbane for a little over 6 years. Other installations in Australia are between 1 and 2 years old.

The primary use of the panels is noise control. For the current review, the panels are intended to be used for noise control in a transportation viaduct and tunnel.

**2. Description of products**

The products under review is the Reapor panels. The core component material of these panels is recycled glass bottles which has been processed to an expanded glass granules.

Figure 1 shows samples of the glass granules and a cross-section of granules that show porosity of the particles.

*Specialist Consultants in*

-Concrete Technology  
Development

-Structure Condition Assessment

-Building Repair Management

-Materials Testing

-Product

**Since 1978**

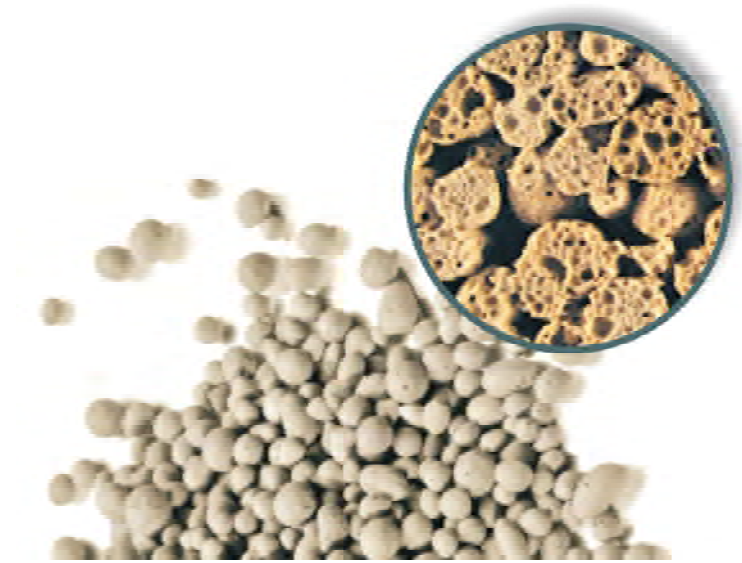

Figure 1: Expanded glass granules; close-up view of the internal structure of the granules

The manufacture of the Reapor panels involves the fusing of the glass granules through a heating process. A sodium silicate (water glass) is added to the granules before sintering. The Reapor panels are therefore, manufactured without a binder. The process is similar to sintering a process that is used in the manufacturing of metals, ceramics, plastics, and other materials. During the process, the atoms in the glass diffuse across the boundaries of the particles, fusing the granules together and creating a homogenous panel. The properties of Reapor panels in terms of exposure are similar to that of the glass.

### **3. Durability Assessment**

The durability of a material is determined by its resistance to degradation when exposed to an aggressive environment. The resistance of a material is combination of the responses of the individual parts and the composite material acting as a whole.

Reapor by nature is similar to glass and its response to environmental exposure will not be significantly different to that of a glass. The durability of glass has been proven over centuries of use. Apart from surface weathering due to abrasion and chemical attack or damage by excessive loads, there are only few factors that damage glass. The recovery of glass fragments in archaeological digs and glass stained windows in ancient churches are testaments of the longevity of glass. Exposure of Reapor to weathering is not expected to be any different.

### **3.1 Environment**

Durability assessment cannot be made in isolation without reference to the environment and the installation process. Figures 2 and 3, show the proposed locations of the panels in the viaduct and tunnel.

Environmental conditions in the tunnel that would affect the durability of the panels include wind (up to 40 m/s), wind-blown rain drawn into the tunnel by trains (surfaces within 150 m from tunnel portals are likely to be frequently wetted), and groundwater seepage (although minimal) containing iron oxide.

The Reapor is to be used in the lining of the parapets and underneath the walkway and walls beneath the walkways.

The locations will expose the panels to the weather in the viaduct sections. Detail descriptions of the locations and installation process is described below.

### **3.2 Locations and installation process**

#### *Reapor - sintered acoustic panels*

Installation overview:

- Substrate prepared to Australian standards - all mould release, surface slurry removed, etc.
- Panels installed using Pyrotek CB Adhesive (cement based, flexible tile adhesive) with >90% coverage. Recommended application method is to use a 12mm notched trowel to apply adhesive to the substrate and back-butter the panel using a 6mm trowel. This provides an adhesive bed of ~5mm. Uneven surfaces will require addition adhesive.
- To prevent excessive ingress of moisture:
  - Panels to be installed on dry substrate, above damp course. We do not recommend the product for installation on damp walls, eg retaining walls.
  - Panels to be installed with flashing or rebated into wall (free drip edge above panel).

- Panels must be installed to drain freely, i.e. Above surface of soil etc. and with a free drip edge on the bottom panel
- Recommend tile spacers used to provide 1-2mm gaps between panels

#### Application 1 – Reapor Exterior walls (vertical)

- Installed as above.
- Panels exposed to sun, wind and rain

#### Application 2 – Reapor Rail and Motorway Tunnel walls

- Installation as above, however flashing is not required as panel is not exposed to weather
- Some exposure to weather blown in at the openings of the tunnels
- Note, there are occasional fire sprinkler tests that will wet the panels

In summary, the installation process for the Reapor allows for the use of the panels in environmental conditions that will exist in the Tunnel. For exterior usage, the Reapor panels will be exposed to the weather (sun, wind, and rain).

While the application of the panels includes interior areas, for durability assessment of material usage on a projected, the worst exposure condition is adopted. Therefore, the environmental exposure for the purpose of this project shall be taken as exterior exposure.

## **4. Service Life Assessment**

### ***4.1 Reapor Panels***

The product is considered as equivalent to glass and the performance of the panel in an exterior environment will be similar to the glass exposed to the weather. Field exposure by the manufacture has shown Reapor has performed without deterioration for nearly 20 years.

Furthermore, historic evidence from archaeological finds and ancient buildings shows glass is durable for hundreds of years. The durability of glass bottles washed ashore after many years at sea confirms the durability of glass exposed to water. The oldest bottle with a message was found in 2015 after 108 years at sea, as part of an experiment undertaken by the

Marine Biological Association of the UK.

Reapor a sintered glass panel is expected to provided service life in the proposed application more than 50 years and even more if it is not damage by mechanical stress in the installed locations.

We trust that this information is of assistance; however please do not hesitate to contact me, should you require anything further.

Yours faithfully

MAHAFFEY ASSOCIATES



Ben Sabaa B.Sc. (Hons), M. Eng. Sc., Ph. D.

Conditions of Use

This report takes into account the particular requirement of our client. It is not intended and should not be relied upon by any third party and no responsibility is undertaken to any third party.

# ELECTRICAL CONDUCTIVITY





Maintaining and Testing Electrical Services

Unit 1 - 2 Sleigh Place Wetherill Park NSW 2164 ABN - 53 105 781 575 Ph - 02 9822 0070 Fax- 02 9757 2498 Mobile - 0419 014 090 E - mates@matesservices.com

Test Report

Customer: Pyrotek, Girraween, NSW
Date: 23/02/2016
Requested By: Alan Woods
Report No: 9765
Location: Mates Work Shop

Purpose of Test: To determine the dielectric insulation integrity
Equipment: Reapor tile
Test Method: The test was performed with the tile lifted from any external influences. Two screws were used at different distances apart at 25mm deep

Table with 3 columns: Distance apart, 5KV DC for 1 min, 1KV DC for 1 min. Rows include 500mm, 450mm, 400mm, 350mm, 300mm, 250mm, 200mm, 150mm, 100mm, 50mm, 25mm.

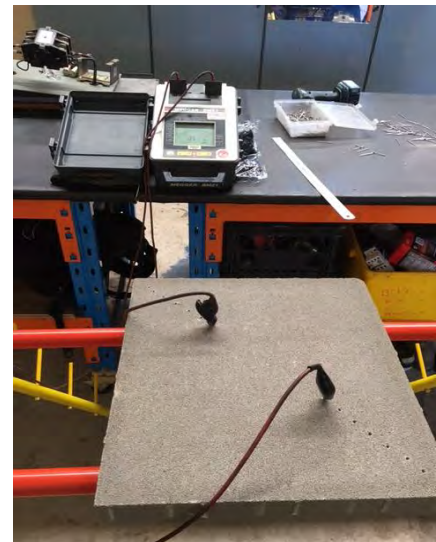

Special Note / Requirement

During test there was no breakdown short, however at 300mm separation and lower the test voltage was not stable at set 1KV and 5KV.

The product under test would be considered of non-conductive materials.

Test in accordance with AS/NZS 3000-2007 -- ( 8.3.6 )

Contact personnel details

Customer Name: Alan Woods Mobile Number: 0416 104 024

Test Electrician: Luke Mounsey Mobile Number: 0419 019 014

Electrician Signature: [Signature] Test Equipment: BM21 Cal:15-7-16



# 2 | VITEROLITE® 900

Being non-conductive, **Viterolite® 900** can be installed safely around electrical communication components as it does not create any electrical interference. It is vital to minimise any interference which can cause a temporary loss of signal or affect communication in mass transit systems.

# VITEROLITE® 900

**Viterolite® 900** is a non-combustible sound absorber ideally suited for areas which require no smoke emission, volatiles, toxic or noxious gases such as tunnels, air shafts or public areas. It is constructed using cement binding agents, ideally used in high wear, high impact and trafficable areas.

It can be custom made into any shape or size. Typical custom applications include wall panels, road barriers, air shaft linings, rail and vehicle tunnels.

Viterolite® 900 has been engineered to optimize maximum sound absorption across a broad frequency range while maintaining a natural concrete-like appearance.



## Features

- Non-combustible - withstands over 1150 °C
- No smoke emission, no toxic or noxious fumes generated when exposed to fire
- Non-fibrous and non-toxic: Safe to handle
- Trafficable: impact resistant from foot traffic and light vehicles
- Non-conductive
- Customizable to suit any application
- Rigid, durable and self supporting with high sound absorption
- High weather, water and UV resistance
- Free draining: porous to allow transfer of water
- Can be used in conjunction with other sound absorbing products to suit acoustic requirements
- Can be easily coated using any exterior paint
- Acoustic renders can be easily applied
- Easily cleaned using detergents or any pressure wash system

## Specifications

<p><b>Rail track tile design:</b> Nominal density: 1800 kg/m<sup>3</sup> Thickness: 170 mm Length: 700 mm Width: 900 mm</p>
<p>Customized size and designs available depending on MOQ.</p>

## Application

- Rail tunnels in-between tracks
- Underground train stations
- Outdoor road barriers or exterior walls
- Trafficable flooring areas
- Plant rooms and substations
- Areas requiring high fire safety
- Transport depots

## VITEROLITE® 900 TECHNICAL DETAILS

No.	Property	Method	Specification
1	Density	-	Minimum density 1500 kg/m <sup>3</sup>
2	Electrical conductivity	"AS/NZS 3000 (tested with 5kV insulation tester)"	Non-conductive
3	Service life \ Design life	--	Documentation asserting a minimum design life of 30 years
4	Acoustic performance	ISO 354, ISO 11654	"Requires a minimum $\alpha_w = 0.70$ (at 170 mm to 230 mm thickness)"
5	Flow resistance	ASTM C522	$1 \times 10^2$ to $5 \times 10^3$ Rayls/m
6	Non-combustibility	AS 1530.1 / ISO 1182	Shall be deemed non-combustible
7	Flammability testing – Cone calorimeter	AS 5637.1	Minimum Group 1 rating
8	Flammability testing & smoke density – fire tests on building materials	AS1530.3	Ignitability, 0
			Spread of flame, 0
			Heat evolved, 0
			Some developed, $\leq 1$
9	Porosity (% Void)		25 to 50%
10	Wind loading		minimum weight of product of 100kg/m <sup>2</sup>
11	Trafficability – prevention of trip hazard	AS 1657	Height tolerance less than or equal to $\pm 2.5$ mm
12	Trafficability – prevention of slip hazard	AS 1657, AS4586 Appendix A	Minimum classification of P5
		AS 1657, AS4586 Appendix B	Minimum classification of D1
13	Non-hazardous material	Classification according to EU Regulation EC 1272/2008 (GHS)	All materials shall be classified as not being Hazardous
14	Volatile organic compound (VOC)	ASTM D5116	Total VOC < 0.5 mg/m <sup>2</sup> /hr
15	Ozone depleting potential (ODP)	--	Zero ODP, no materials with ODP added, used or generated during manufacture
16	Water resistant & water permeable to allow drainage	--	Shall be permeable and resistant to water, to allow drainage

# TECHNICAL DATA SHEET



## VITEROLITE® 900

### non-combustible sound absorber

Viterolite® 900 is a non-combustible sound absorber ideally suited for areas which require no smoke emission, volatiles, toxic or noxious gases such as tunnels, air shafts or public areas. It is constructed using cement binding agents, ideally used in high wear, high impact and trafficable areas.

It can be custom made into any shape or size. Typical custom applications include wall panels, road barriers, air shaft linings, rail and vehicle tunnels.

Viterolite® 900 has been engineered to optimize maximum sound absorption across a broad frequency range while maintaining a natural concrete-like appearance.

The product design allows for drainage due to the material's porous nature. It has the strength to handle foot traffic and light vehicles making it ideal for construction of walkways.

Viterolite® 900 can also be utilised around electrical components as it is non-conductive.

For more information on the available designs, please contact your local Pyrotek representative.



Rail track tile design made out of Viterolite® 900

### applications

- Rail tunnels in-between tracks
- Underground train stations
- Outdoor road barriers or exterior walls
- Trafficable flooring areas
- Plant rooms and substations
- Areas requiring high fire safety
- Transport depots

### features

- Non-combustible
- No smoke emission, no toxic or noxious fumes generated when exposed to fire
- Non-fibrous and non-toxic: safe to handle
- Trafficable: impact resistant from foot traffic and light vehicles
- Non-conductive
- Customizable to suit any application
- Rigid, durable and self supporting with high sound absorption
- High weather, water and UV resistance
- Free draining: porous to allow transfer of water
- Can be used in conjunction with other sound absorbing products to suit acoustic requirements
- Can be easily coated using any exterior paint
- Acoustic renders can be easily applied
- Easily cleaned using detergents or any pressure wash system

### SPECIFICATIONS

Colour	Grey cement
Available	<b>Rail track tile design:</b> Thickness: 170 mm Length: 700 mm Width: 900 mm
	Customised size and designs available depending on MOQ



## PRODUCT SPECIFICATIONS

Product	Nominal density	Standard thickness	Standard length	Standard width	Nominal weight
Viterolite® 900 Rail track tile design	1800 kg/m <sup>3</sup>	170 mm	700 mm	900 mm	160 kg

Tolerances: Length: ±5 mm, Width: ±5 mm, Thickness: ±5 mm. Customised size and design available.

## MATERIAL PROPERTIES

Test method	Property	Report	Results	
AS/NZS 3000	Electrical conductivity	PYRO-TT-001	Non-conductive	
AS 1530.1 / ISO 1182	Fire resistance	FNC11917	Non-combustible	
AS 1530.3	Method for fire tests on building materials, components and structures	17-005996	Ignitability	0
			Spread of flame	0
			Heat evolved	0
			Smoke developed	0-1
AS 1657, AS 4586	Fixed platforms, walkways, stairways and ladders: Slip resistance classification of new pedestrian surface materials	R16545a	Slip resistant class P5 (Appendix A) D1 (Appendix B)	
Design Life and maintenance	Service life assessment	DRM-17-L01R-10929	30 years with proper use, installation and maintenance	
ASTM D5116	TVOC Specific area emission rate	CV180902	Emissions are less than Green Star recognised threshold of 0.5 mg/m <sup>2</sup> /hr	
ISO 10545-4 / AS 4459.4	Flexural strength or Modulus of rupture	27718BD	2.9 N/mm <sup>2</sup>	

## ACOUSTIC PERFORMANCE

Frequency (Hz)	Absorption Coefficients
100	0.19
125	0.23
160	0.52
200	0.88
250	0.93
315	0.92
400	0.8
500	0.65
630	0.6
800	0.69
1000	0.9
1250	0.81
1600	0.73
2000	0.83
2500	0.8
3150	0.82
4000	0.84
5000	0.83
NRC	0.85
SAA	0.8
$\alpha_w$	0.80 (L)

### Viterolite® 900 - Rail Track Tile

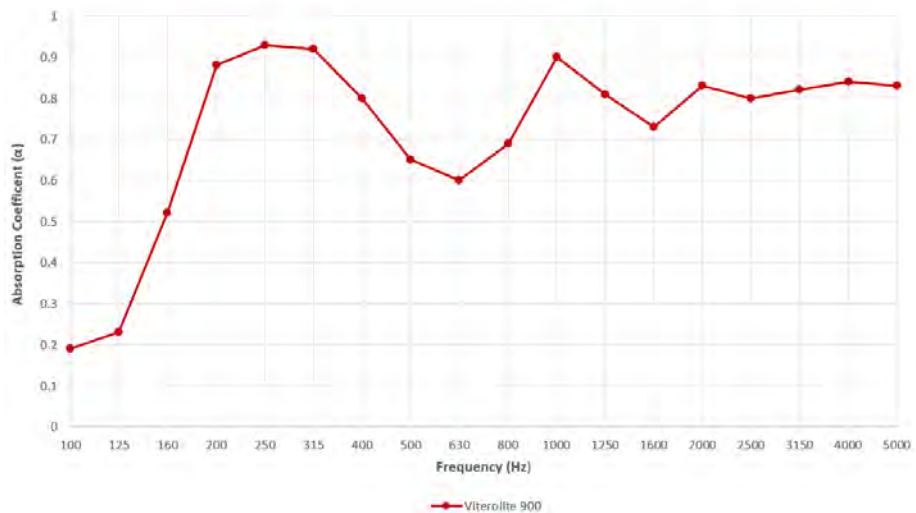

Tested to ISO 354:2003 at CSIRO, Australia | Report Number: AC323-01-1

The above results are based on the Viterolite® 900 rail track tile design

For further information and contact details, please visit our website [pyroteknc.com](http://pyroteknc.com)

*Caveats: Specifications are subject to change without notice. The data in this document is typical of average values based on tests by independent laboratories or by the manufacturer and are indicative only. Materials must be tested under intended service conditions to determine their suitability for purpose. The conclusions drawn from acoustic test results are as interpreted by qualified independent testing authorities. Nothing here releases the purchaser/user from responsibility to determine the suitability of the product for their project needs. Always seek the opinion of your acoustic, mechanical and fire engineer on data presented by the manufacturer. Due to the wide variety of individual projects, Pyrotek is not responsible for differing outcomes from using their products. Pyrotek disclaims any liability for damages or consequential loss as a result of reliance solely on the information presented. No warranty is made that the use of this information or of the products, processes or equipment to which this Information Page refers will not infringe any third party's patents or rights.*  
**DISCLAIMER:** This document is covered by Pyrotek standard Disclaimer, Warranty and © Copyright clauses. See [pyroteknc.com/disclaimer](http://pyroteknc.com/disclaimer).



# INSTALLATION GUIDE



## VITEROLITE® 900

This Installation Guide provides recommendations to maximise the service life in outdoor applications. Viterolite® 900 should always be installed over surfaces that are flat, clean, free of contaminants and with adequate drainage.



Rail track tile design made out of Viterolite® 900

### WORKING HEALTH AND SAFETY

- Failure to follow these guidelines may result in a reduced product life, cracking or other deterioration of the panels.
- Gloves, protective goggles and any other appropriate safety equipment based on local health & safety requirements and safe work practice must be worn by applicator.

### KEY INSTALLATION REQUIREMENTS

Viterolite® 900 panels should be installed on a flat level surface of rigid cement slab with suitable strength and thickness. Alignment of top surface of adjacent panels should be of consistent height, providing a smooth continuous surface to eliminate potential trip hazards between individual panels.

Recommended installation is with minimum 80g of adhesive on each corner of the tile's base.

***A thicker adhesive layer may be required depending upon the roughness of the substrate surface. To level the floor in the installation area, additional adhesive or grinding of the surface should be considered in order to prepare uneven surfaces.***

Viterolite 900 should only be installed in areas with suitable drainage.

### SURFACE PREPARATION

- All substrates must be clean and free from laitance, curing compounds, dirt, dust, grease, oil and any other contaminants.
- When an adhesive is used, all substrates should be washed with clean water just prior to the application of the adhesive or leveling compound. Care must be taken in the preparation of concrete to ensure all traces of release agents and curing compounds are removed, if in doubt prepare the substrate using a pressure washer to expose the fine aggregates in the matrix of the concrete as this will ensure a clean substrate.
- For rough or uneven surfaces, addition of cementitious floor leveling compound or grinding of the surface to a flat finish is required.

*Viterolite® 900 was developed with the aim of providing trafficable acoustic absorber*

### applications

- Applications requiring high fire ratings
- Airports, stations, and car parks
- Railway and motorway tunnels



## ADHESIVE APPLICATION

- When used, adhesive must be installed according to recommendations on the package.
- Once the surface has been appropriately prepared in accordance with the instructions, apply the adhesive onto the surface.
- Apply 320g of adhesive to each panel (80g of adhesive to each corner)
- If adhesive does fall on front surface of Viterolite, remove excess adhesive without smudging, smearing or wiping it over the surface of the panel.
- Viterolite 900 tile should be flat after installation - no excessive gaps and base parallel to the substrate.
- Clean up excess adhesive / sealant from the substrate with Methylated Spirits or 100% Industrial Alcohol Cleaner.

## DESIGN DETAIL

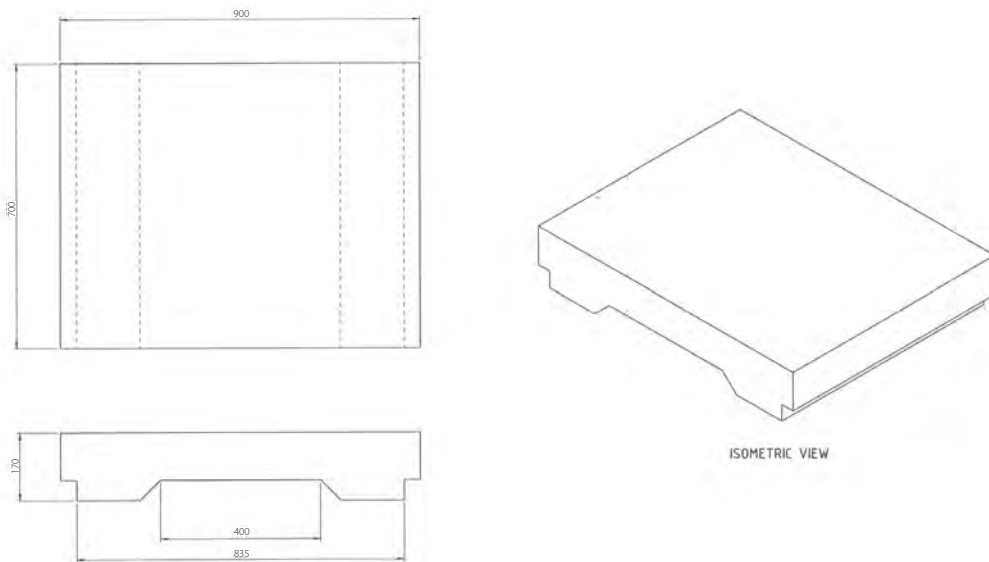

*Standard Viterolite 900 design - custom design available (MOQ apply)*

## INSTALLATION

- Check the installation site for accessibility and appropriate installation equipment for the delivery of Viterolite® 900 panels. Viterolite® 900 is supplied vertically upright on pallets. Panels will require lifting and may require rotating 90 degrees to allow access for forklift tines for individual panel lifting. Prior to handling, conduct visual inspection of panels to confirm compliance to specification and to check for any major defects.
- Unloading point or storage area shall be a hard, level, clean, dry and well drained ground. Store panels using “First-In, First-Out” principles, on a pallet with appropriate restraints.
- Forklifts used to lift panels should be operated by a qualified operator, in a manner compliant with the regional legislative requirements. All other personal shall remain clear of the forklift while in operation. Viterolite® 900 panels are designed to be lifted using a forklift and tines should be carefully adjusted to ensure that they fully utilise the panel lifting points, and prevent lateral movement of the panel.
- The panels must not bridge expansion joints of substrate. Expansion joints must be provided to allow movement. Joints should not be less than 4 mm and not wider than 6 mm. Use flexible sealant where required.
- Panels should be spaced approximately 4 mm apart using tile spacers. Ensure panels are laid evenly, and that the variation in height between adjacent panels is less than 5 mm. Where panel height variation is greater than 5mm, the flooring substrate should be checked to ensure that it is clean and leveled. If required, it shall be raised with cementitious floor leveling compound or ground to correct floor leveling.

## CARE, REPAIR & MAINTENANCE

- Replace any cracked or broken panels.
- Clean off any efflorescence by hosing down or using efflorescence remover.
- The porosity of the panels should not be blinded by dirt or any other contaminants.

## WEATHERING

Viterolite® 900 is a porous stone-like material that may weather and age naturally in the elements in a similar way to natural stone.

In outdoor applications, Viterolite® 900 may show signs of efflorescence, a temporary condition which can be removed by rinsing with a hose or in most cases over time rainwater steadily removes the deposit leaving the original colour of the panel unharmed.

*Efflorescence does not affect the quality, acoustic performance or functionality of Viterolite® 900.*

## RECOMMENDED ADHESIVE

Pyrotek recommends Fix8 Adhesive.

**Fix8 Adhesive** is a silicone based flexible polymer adhesive, with easy application via caulking gun. At ambient temperatures of 23 °C (73 °F) and humidity (50%R.H) it provides a 30 minute skin formation via moisture cure. Ensure adequate ventilation during application and cure.

# HANDLING GUIDE



## VITEROLITE 900 TRANSHIPPING AND HANDLING GUIDE

*This guide is designed to give advice and direction for the general transshipping and storage of Viterolite 900 acoustic tiles. This is a general guide only and all normal health and safety procedures should be followed, and site conditions considered to complete a thorough risk assessment.*

**The Recipient agrees to strictly follow and observe all manufacturer instructions and a failure to strictly store or handle the goods as directed may lead to personal injury, death and/or property damage, including damage to the goods. Pyrotek disclaims and excludes all liability for claims caused by the Recipient not strictly following the manufacturer's recommended storage and handling procedures.**

**\*\*BEFORE HANDLING OR PERFORMING LIFTING OPERATIONS PLEASE BE AWARE THAT VITEROLITE 900 IS A DURABLE PRODUCT, BUT CARE SHOULD BE TAKEN AS TO MINIMIZE THE OCCURANCE OF AND PREVENT DAMAGE AND INJURY IF BREAKAGE OCCURS DURING LIFTING OPERATIONS.**



### Shipping and Packing

Viterolite is shipped on wooden pallets, vertically stacked 8 tiles high and strapped with metal banding. Standard Viterolite 900 panels are 900 x 700 mm at 170 mm high. Each pallet is 0.9 x 0.7 x 1.6 m (Length x Width x Height). The weight of each pallet is approx. 1000 – 1200 kg. Weight of each tile is approx. 100-180 kg. These values will vary based upon project specific design and style. Refer to product TDS for more information.



### Handling Palletised Viterolite 900

1. Tilt tines back and tie/strap panels to mast to ensure the tiles don't topple over when moving.
2. Handle with care and avoid impact.
3. Avoid sudden drops when moving via forklift.
4. Avoid bumps when travelling with pallets on forklift.
5. Keep area around forklift clear, suggest:
  - a. 3m exclusion zone. Spotter should remain clear of the forklift, at a safe distance.
6. Move only with forklift or pallet jack.



## Unpacking Viterolite 900 pallets.

1. Pallet should be placed in a safe location prior to unpacking, clear of other Viterolite 900 pallets, visual obstructions, or hazards.
2. Inspect for damaged or cracked tiles prior to unpacking. Additional care and alternative lifting method may be needed for pallets containing damaged tiles.
3. Adjust tines of forklift so that both tines are spaced as widely as possible for stability, but both tines fit between the feet of the Viterolite 900. For some designs, customized tines may need to be used. In some applications, cement block grabbers are suitable for use.
  - a. When adjusting the tines on the forklift to accommodate the width of Viterolite 900, make sure the tine is not over the fitting notch as this can cause the pallet to topple.
4. When lifting:
  - a. Lift one (1) Viterolite 900 tile at a time.
  - b. Handle with care and avoid impact.
  - c. Avoid sudden drops when moving via forklift.
  - d. Avoid bumps when travelling with pallets on forklift.
  - e. Keep area around forklift clear, suggest a 3m exclusion zone. Spotter should remain clear of the forklift, at a safe distance.

## Storage

1. Do not stack pallets on top of each other or stack anything on top.
2. Protect from any mechanical damage (Bumps or knocks).
3. Make sure pallets are stored on level ground, placed gently down not shunted into place with tines of forklift.
4. Pallets should be covered to prevent moisture ingress to prevent moisture ingress, which would cause damage to strapping & pallets.
5. When covered ensure also adequate ventilation of the covering to prevent sweating and condensation build up.



# SERVICE LIFE





**MAHAFFEY ASSOCIATES PTY LTD**

(ABN 90 001 629 036)

Incorporating BEMAC Laboratories

Unit 9 / 108-110 Percival Road (P O Box 2162), Smithfield NSW 2164

Ph (02) 9756 4003

Fax (02) 9757 4228

Email mahaffey@mahaffey.com.au

*DRM/17/L01R/10929*

3 March 2017

Pyrotek Pty. Ltd.

147 Magowar Road

**GIRRAWEE NSW 2145**

Attention: Bruce Hermes

Dear Sir,

**Re: Service life Assessment of Viterolite 900**

**1. Background**

The report covers a review the Viterolite 900 panels with the view of providing durability and the service life assessment.

The primary use of the panels is noise control. For the current review, the panels are intended to be used for noise control in a transportation viaduct and tunnel.

**2. Description of products**

The product under review is the Viterolite 900 panels. The core component material of these panels is natural coarse aggregate in a cement matrix..

The manufacture of the Viterolite 900 involves casting a mixture of the manufactured fine aggregate and Portland cement in moulds on a vibrating table. The cement acts as the binder.

After casting, the panels sit in the moulds for 24 hours. They are then removed from the mould, wetted thoroughly with water, wrapped in plastic and left for 30 days to cure. Some time after this, they are deliver to client, still wrapped in plastic.

The aggregate is Cowra C33b Washed Concrete Sand but only the fraction sitting between

**Specialist Consultants in**

-Concrete Technology  
Development

-Structure Condition Assessment

-Building Repair Management

-Materials Testing

-Product

**Since 1978**

the 1.18 and 4.75mm sieves is used. Details of the sand are included in Appendix A.

### **3. Durability Assessment**

The durability of a material is determined by its resistance to degradation when exposed to an aggressive environment. The resistance of a material is a combination of the responses of the individual parts and the composite material acting as a whole.

Viterolite consists of manufactured sand in a cement-based binder. The issues that will determine the durability of this product are identified as the resistance of the composite material to thermal, moisture, and chemical exposure. In an outdoor environment, these are the main factors which act together to cause weathering.

The components of Viterolite, Portland cement and quartz manufactured, are durable materials in both indoor and outdoor situations. Their durability is not in doubt. This is particularly the case as the manufacturing process ensures that the product is kept wet for a period of 30 days after manufacture. Portland cement based materials require water in their early life to ensure that there is as close to complete hydration of the cement as possible. Wetting the product and then wrapping it in plastic is very close to full water curing and this will allow the inherent durability performance of the product to be achieved.

The interaction between the cement binder and the aggregate is an area that could affect the durability of the product, depending on the nature of the aggregate. Alkalis in cement have been known to cause a reaction with certain silicate minerals in aggregates (alkali-silica-reaction - ASR). The reaction product in the form of a gel is more voluminous than the siliceous components from which it formed (it occupies more solid space), is mobile, and under some conditions, causes localized stresses resulting in expansion and cracking.

The conditions required for ASR to occur are:

- A sufficiently high alkali content of the cement (or alkali from other sources)
- A reactive aggregate,
- Water - ASR will not occur if there is no available water in the concrete, since alkali-silica gel formation requires water

The above conditions are met in an outdoor exposure. In dry environment the product will



not be exposed to the potential for ASR because of the lack of moisture. In an outdoor condition, the potential for ASR needs to be investigated. The potential for ASR was investigated by petrography.

### 3.1 Environment

Durability assessment cannot be made in isolation without reference to the environment and the installation process. Figures 2 and 3, show the proposed locations of the panels in the viaduct and tunnel.

Environmental conditions in the tunnel that would affect the durability of the panels include wind (up to 40 m/s), wind-blown rain drawn into the tunnel by trains (surfaces within 150 m from tunnel portals are likely to be frequently wetted), and groundwater seepage (although minimal) containing iron oxide.

The Viterolite 900 will be used between the tracks and around the tracks (V1 and T1 in Figures 1 and 2).

The locations will expose both panels to the weather in the viaduct sections. Detail descriptions of the locations and installation process is described below.

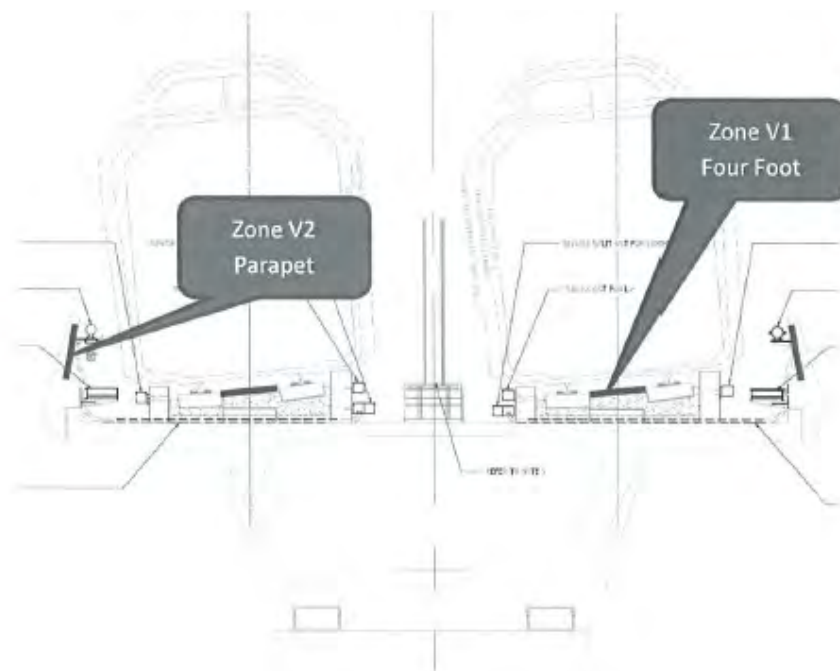

Figure 1: Typical cross-section of viaduct

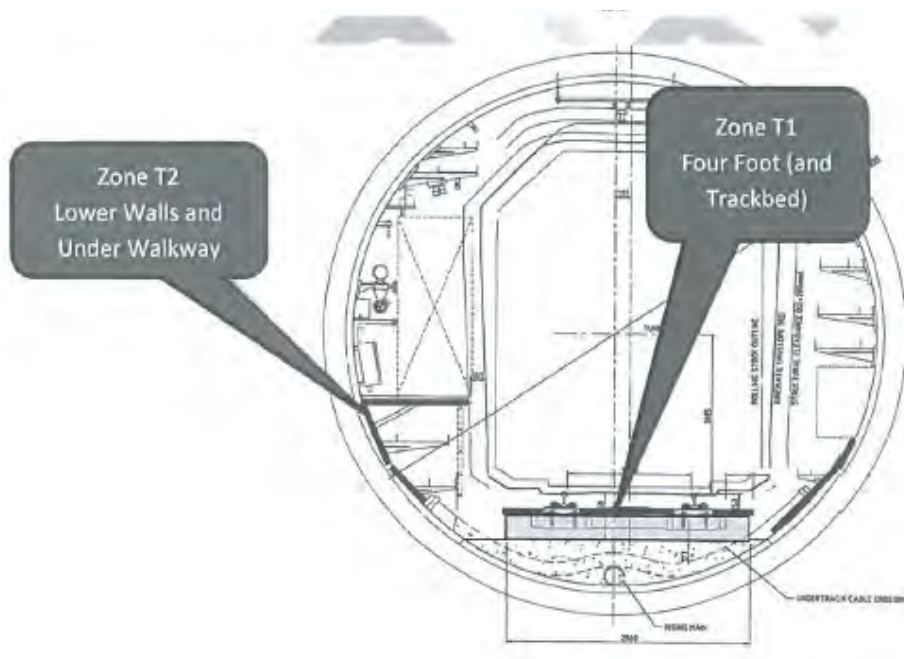

Figure 2: Typical tunnel cross-section

### 3.2 Locations and installation process

#### *Viterolite 900 - cement bonded panels*

##### Installation overview:

- Substrate prepared to Australian standards - all mould release, surface slurry removed, etc.
- Panels are hydrophobic and promote water runoff.
- Substrate to provide fall to enable drainage from top and below panel
- Panels installed using Pyrotek CB Adhesive (cement based, flexible tile adhesive) with >90% coverage. Recommended application method is to use a 12mm notched trowel to apply adhesive to the substrate and back-butter the panel using a 6mm trowel. This provides an adhesive bed of ~5mm. Uneven surfaces may require addition adhesive.

#### Application 3 – Viterolite 900 flooring in Rail Tunnels

- Panels installed horizontally and exposed to full weather (sun, wind, rain)
- Occasional foot traffic for maintenance crews following commissioning of the tunnel (there is an elevated walkway for access along the tunnel, foot traffic to be limited to immediate area requiring maintenance).
- Suitable for foot traffic for emergency evacuation of tunnels

#### Application 4 - Viterolite 900 flooring in Rail Viaducts

- Panels installed horizontally and exposed to full weather (sun, wind, rain)
- Occasional foot traffic for maintenance crews following commissioning of the tunnel. As there is no separate walkway, foot traffic may be higher than in the tunnel.
- Suitable for foot traffic for emergency evacuation of tunnels

In summary, the installation process for the Viterolite 900 will result in the panels being exposure to the weather, with no restrictions on the prevention of excessive moisture ingress.

While the application of the panels includes interior areas, for durability assessment of material usage on a projected, the worst exposure condition is adopted. Therefore, the environmental exposure for the purpose of this project shall be taken as exterior exposure.

#### **4. Service Life Assessment**

The aggregate used in the Viterolite 900 panels is a hard sound, low porosity rock. The testing included in the attached report shows that it meets the requirements of AS2758.1, "Aggregates and rock for engineering purposes – concrete aggregates". This makes it suitable for use in the manufacture of concrete or other cement based materials for use in structures with a design life of 50 years or more.

The possible risk of ASR due to silica in the manufactured sand aggregate was assessed in the petrographic examination and this indicates that the material has a very low risk of ASR and would meet the requirements of a range of high performance specifications for structures with design lives well in excess of 30 years.

On the basis of the petrographic analysis, it is concluded that Viterolite 900 can be considered as a mixture of Portland cement and sand.

As a compressed “sand cement” product, it will not be damaged by exposure to the weather. It is expected that the material will provide a service life significantly longer 30 years provided it is not damage by mechanical stress.

We trust that this information is of assistance; however please do not hesitate to contact me, should you require anything further.

Yours faithfully,

Mahaffey Associates Pty Ltd



**D. R. Mahaffey**

Conditions of Use

This report takes into account the particular requirement of our client. It is not intended and should not be relied upon by any third party and no responsibility is undertaken to any third party.

# ELECTRICAL CONDUCTIVITY





**VITEROLITE 900**  
**Tile Test Report**

**PYROTEK**  
**Girraween N.S.W**

Vision Site Development P/L  
ABN: 86114753267

PO Box 4749, Casula Mall  
Casula NSW 2170

HV and LV Switchgear  
Substation Maintenance

Power Factor Maintenance  
Earth Testing

Infra-red Thermography  
Industrial Installations.



PO Box 4749, Casula Mall  
Casula NSW 2170  
ABN: 86114753267  
Phone: 0408 001 617  
Email: [visionsite@hotmail.com](mailto:visionsite@hotmail.com)

Customer: PYROTEK

Site: Girraween N.S.W

Date: 24/04/2017.

Technician: Bob Woods.

**Scope of Works:**

Perform insulation voltage tests to determine dielectric insulation integrity of insulation tile as per AS/NZS 3000-(8.3.6)

**Work Carried Out:**

Various number of insulation tests between distances of 25 mm up to 1050 mm apart using voltages of 1000 volts & 5000 volts on a fully DRY Test Tile supplied.

**Summary:**

Test was performed with tile supported away from any external influence to prevent any disruption of results.

**Recommendations:**

Nil.



# Vision Site Development

## Electrical & Mechanical Site Services

Licence No. -

NSW-257221C

QLD-79173

ABN - 86114753267

Mobile - 0408-001617

Mobile - 0439-688873

Email - visionsite@hotmail.com

### Test Report

**Customer:** Pyrotek Girraween N.S.W  
**Date:** 24-04-2017  
**Requested By:** Benjamin Dowdell  
**Report No:** PYRO-TT-001  
**Location:** Pyrotek Girraween N.S.W

**Purpose of Test:** To determine the dielectric insulation integrity

**Test sample:** Viterolite 900

**Test Method:** The test was performed with the tile lifted from any external influences. Two screws were used at different distances apart at 50 mm deep

Distance apart	5KV DC for 1 min			1KV DC for 1 min		
500mm	304	Meg	$\Omega$	1.60	Gig	$\Omega$
450mm	141	Meg	$\Omega$	273	Meg	$\Omega$
400mm	102	Meg	$\Omega$	181	Meg	$\Omega$
350mm	86.7	Meg	$\Omega$	185	Meg	$\Omega$
300mm	81.9	Meg	$\Omega$	172	Meg	$\Omega$
250mm	39.5	Meg	$\Omega$	59.5	Meg	$\Omega$
200mm	31.6	Meg	$\Omega$	46.9	Meg	$\Omega$
150mm	15.8	Meg	$\Omega$	26.1	Meg	$\Omega$
100mm	9.00	Meg	$\Omega$	12.2	Meg	$\Omega$
50mm	9.52	Meg	$\Omega$	15.1	Meg	$\Omega$
25mm	4.70	Meg	$\Omega$	6.93	Meg	$\Omega$



### Special Note / Requirement

During all tests there was no recorded breakdown short, tile appeared stable for results.

Tile produced for testing would be considered of non-conductive materials in a dry manner.

Test in accordance with AS/NZS 3000-2007 -- ( 8.3.6 ) Test Equipment - HT7051 5kv Insulation Tester.

### Contact personnel details

Customer Name: Benjamin Dowdell Mobile Number: 02-8868-2088

Test Electrician: Bob Woods Mobile Number: 0408-001617

Electrician Signature: 





# Vision Site Development

## Electrical & Mechanical Site Services

Licence No. -  
NSW-257221C  
QLD-79173  
ABN - 86114753267

Mobile - 0408-001617  
Mobile - 0439-688873  
Email - visionsite@hotmail.com

### Test Report

**Customer:** Pyrotek Girraween N.S.W  
**Date:** 24-04-2017  
**Requested By:** Benjamin Dowdell  
**Report No:** PYRO-TT-001  
**Location:** Pyrotek Girraween N.S.W

**Purpose of Test:** To determine the dielectric insulation integrity

**Test Sample:** Viterolite 900

**Test Method:** The test was performed with the tile lifted from any external influences. Two screws were used at different distances apart at 50 mm deep

Distance apart	5KV DC for 1 min			1KV DC for 1 min		
1050mm	20.1	Gig	$\Omega$	50.6	Gig	$\Omega$
1000mm	8.40	Gig	$\Omega$	17.1	Gig	$\Omega$
950mm	3.58	Gig	$\Omega$	7.24	Gig	$\Omega$
900mm	2.48	Gig	$\Omega$	5.07	Gig	$\Omega$
850mm	1.86	Glg	$\Omega$	3.67	Gig	$\Omega$
800mm	1.52	Gig	$\Omega$	3.07	Gig	$\Omega$
750mm	855	Meg	$\Omega$	1.84	Gig	$\Omega$
700mm	773	Meg	$\Omega$	1.58	Gig	$\Omega$
650mm	464	Meg	$\Omega$	897	Meg	$\Omega$
600mm	299	Meg	$\Omega$	568	Meg	$\Omega$
550mm	334	Meg	$\Omega$	968	Meg	$\Omega$



### Special Note / Requirement

During all tests there was no recorded breakdown short , tile appeared stable for results.

Tile produced for testing would be considered of non-conductive materials in a dry manner.

Test in accordance with AS/NZS 3000-2007 -- ( 8.3.6 ) Test Equipment - HT7051 5kv Insulation Tester.

### Contact personnel details

Customer Name: Benjamin Dowdell Mobile Number: 02-8868-2088

Test Electrician: Bob Woods Mobile Number: 0408-001617

Electrician Signature: 

# 3 | DECIDAMP® RTD

Decidamp® RTD is constructed from viscoelastic material designed to dampen track noise in tunnels and other areas. Engineered perfectly to the track design it is also flexible to be adapted to various track dimensions around the world.

# DECIDAMP® RTD

**Decidamp® RTD** is a high performance polymeric damping pad designed to greatly reduce structure- borne noise generated during contact between track and train wheels in critical frequencies between 630 and 2500Hz. Addressing broad frequency noise, including an effective rail damper system will reduce vibration and protect from structural fatigue.

Rail dampers are suitable for use outdoors.

## Features

- Lighter, better damping properties
- Effective, high performance noise attenuation
- Designed to fit perfectly to the track design.
- Quick, easy install using specially designed brackets
- Resistant to weather over an extended period of time

## Recommended Application

- Rail tracks in tunnels and surrounding areas



### DECIDAMP RTD

**Noise reducing extensional rail damper**

Made in Australia in ISO certified manufacturing premises.

Standard sizes will vary according to track design. Please contact your local Pyrotek Office to discuss requirements.

Quick, easy installation using specially designed brackets.

### HEALTH & SAFETY STATEMENT

Decidamp® RTD is non-toxic and safe to handle by methods prescribed in safety datasheet. No ozone depleting substances are used during the manufacture of product.

**Designed to install with engineered clips and contact paste.**

Developed for high strength bonds with Decidamp® RTD. Excellent working properties for installation. The chemical cure is suitable to exposure to rail track conditions.

# TECHNICAL DATA SHEET



## DECIDAMP® RTD - AS60-8500

### noise reducing extensional rail damper

Decidamp RTD is a rail track damper designed to effectively reduce noise generated by track resonance. The high performance polymer composite provides significant damping via a tuned mass system. Along with noise reduction, it can also assist in reducing rail metal fatigue or corrugation growth, lowering maintenance cost.

Decidamp RTD can be designed and tuned to meet customer noise reduction requirements.

By using our internal research and development team, together with leading acoustic engineers, extensive product development was performed to create an optimised solution. On-site field testing also ensures dampers are optimised to deliver maximum effectiveness on any track configuration.

Decidamp RTD can be easily fitted to existing and new rail track as a method of complying with noise legislation and environmental planning regulations. Decidamp RTD dampers are easily attached to either side of the rail using specially designed brackets.

Decidamp RTD can be supplied with a metal face plate to provide UV and fire protection for increased product durability. Decidamp RTD is a cost-effective option to reduce radiating noise from railway rolling track.

#### VOC, ODP, HEALTH AND SAFETY

Decidamp RTD is non-toxic and safe to handle by methods prescribed in Safety Data Sheet. No Ozone depleting substances are used during the manufacture of Decidamp RTD.

#### SPECIFICATIONS

Colour	Black
Available	Track profile: AS60 Length (mm): 400 Weight (kg): 8.5 Noise reduction: Up to 6.5 dB(A)*
	Other track profiles available on MOQ

\*Refer to acoustic performance tables



### features

- Decidamp RTD can effectively reduce rail-radiated noise
- Highly optimized performance to weight ratio - minimized weight for ease of installation
- Can reduce rail fatigue/corrugation
- Minimise track maintenance
- Prolong track lifespan
- Easily installed, reducing down time during commissioning of new rail tracks or during maintenance
- Dampers can be made available for various track profiles
- Damping performance is tuned to be effective across the typical frequency range of track vibration
- Minimal maintenance requirement after installation, long life once fitted
- Does not interfere with other elements of the rail assembly
- No interference with other track maintenance e.g. rail grinding
- Reduces the reliance on noise barriers
- Metal face plate can be included for increased durability
- Glue point locations to reduce lateral movement

## ACOUSTICS PERFORMANCE

### Track Decay Rate

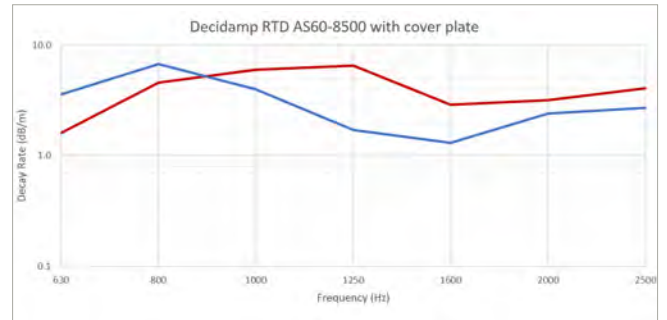
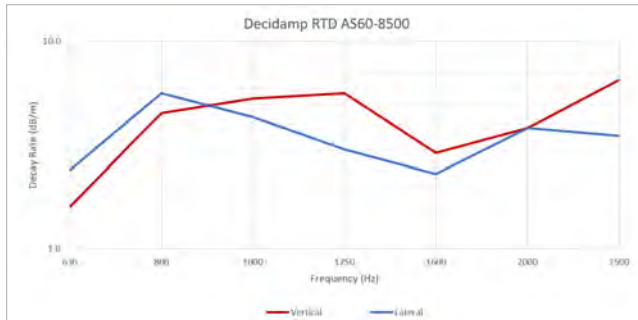

Product	Direction	Decay Rate (dB/m) at One Third Octave Band Centre Frequency (Hz)							Arithmetic average of 1/3 octave bands (630-2500hz)
		630	800	1000	1250	1600	2000	2500	
Decidamp RTD AS60-8500 *	Vertical	1.6	4.5	5.3	5.6	2.9	3.8	6.5	4.3
	Lateral	2.4	5.6	4.3	3.0	2.3	3.8	3.5	3.6
Decidamp RTD AS60-8500 ** with cover plate	Vertical	1.6	4.6	6.0	6.6	2.9	3.2	4.1	4.1
	Lateral	3.6	6.8	4.0	1.7	1.3	2.4	2.7	3.2

Report number: \*610.19202-L18-v1.0-20230131 \*\*610.19202-L11-v1.0-20220330

Nominal measurement of track decay rate (TDR) of 6 m length track with 0.7 m spacing between Decidamp RTD dampers.

Correct installation is required to achieve best results, variation in measured TDR is expected for variation in track length, spacing or end test condition.

## PRODUCT SPECIFICATIONS

Product Name	Colour	Nominal weight (kg)	Length (mm)	Operating Temperature	Installation method
Decidamp RTD AS60-8500	Black polymer with optional metal shroud	8.5	400	Optimal: 10 to 40 °C Continuous: -40 to 80 °C Maximum Intermittent 130 °C	2x stainless steel clips per Decidamp RTD damping block.

Enquire for alternate method of installation.

## MATERIAL PROPERTIES

Test method	Property	Report no.	Results	
AS1530.3 Tested with cover plate	Method for fire tests on building materials, components and structures	21-000883	Ignitability	0
			Spread of flame	0
			Heat evolved	0
			Smoke developed	3
ASTM D5116	TVOC specific area emission rate	V2010039	Emissions are less than the Green Star recognised threshold of 0.5 mg/m <sup>2</sup> /hr	
EN 17084, NF X 70-100 (EN 45545-2) Tested without cover plate	Fire test, analysis of gaseous effluents produced by thermal degradation	501693	C.I.T = 0.28 Complies with strictest implementation of HL3 criteria, a maximum permissible value of 0.75	
Design life and maintenance	Service life assessment	BAS/20/L01/10929	35 years with proper use, installation and maintenance	
STARDAMP calculation	Typical noise mitigation STARDAMP modelled scenario Sound pressure levels at 7.5 m dB(A)	TK490-07F03	Up to 6.5 dB(A) reduction in noise from rail track source.	
		TK490-04F01	With cover plate: Up to 5.6 dB(A) reduction in noise from rail track source.	

STARDAMP calculations are system dependent and assessment should be done on track forms specific to end-use



## TRACK AND PRODUCT DRAWINGS

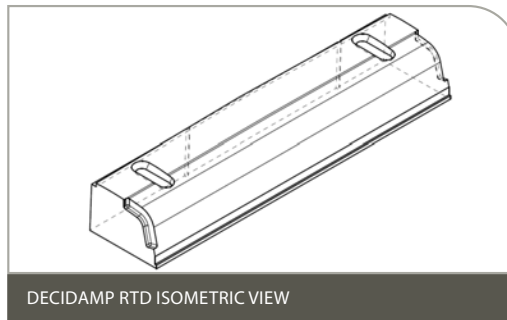
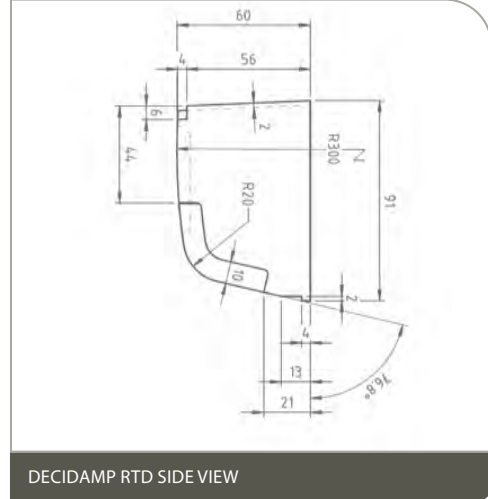
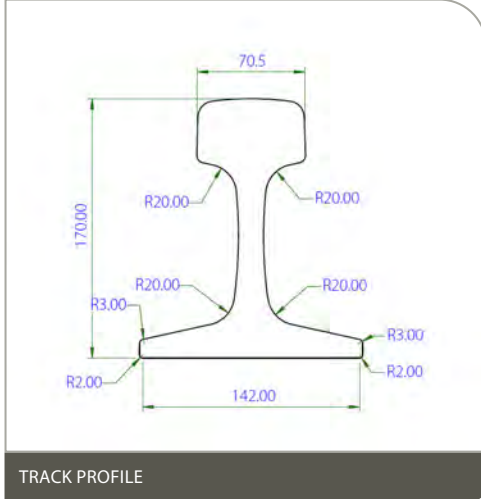

## OPTIONAL ACCESSORY FOR FIRE, UV , MECHANICAL WEAR RESISTANCE



For further information and contact details, please visit our website [pyroteknc.com](http://pyroteknc.com)

*Caveats: Specifications are subject to change without notice. The data in this document is typical of average values based on tests by independent laboratories or by the manufacturer and are indicative only. Materials must be tested under intended service conditions to determine their suitability for purpose. The conclusions drawn from acoustic test results are as interpreted by qualified independent testing authorities. Nothing here releases the purchaser/user from responsibility to determine the suitability of the product for their project needs. Always seek the opinion of your acoustic, mechanical and fire engineer on data presented by the manufacturer. Due to the wide variety of individual projects, Pyrotek is not responsible for differing outcomes from using their products. Pyrotek disclaims any liability for damages or consequential loss as a result of reliance solely on the information presented. No warranty is made that the use of this information or of the products, processes or equipment to which this Information Page refers will not infringe any third party's patents or rights.*  
 DISCLAIMER: This document is covered by Pyrotek standard Disclaimer, Warranty and © Copyright clauses. See [pyroteknc.com/disclaimer](http://pyroteknc.com/disclaimer).



# DECIDAMP® RTD CLIP - AS60-8500

## stainless steel clip

Decidamp RTD Clips are 4mm 304 stainless steel clips used to install Decidamp RTD dampers. The natural finish clips are resistant to environmental corrosion, providing a long service life.

The clips are suitable for use with AS60 rail tracks and Decidamp RTD AS60-8500 dampers, with other track profiles available on request. Decidamp RTD Clips are installed to existing or new tracks by simply placing over RTD dampers and impacting / pushing with installation tool or rubber mallet into place. Once installed, the clips can be easily removed for track maintenance if required. Please refer to Decidamp RTD Installation Guide.

Decidamp RTD Clips provide an ideal clamping force to ensure RTD dampers are secured in place, optimizing damping performance, while not interfering with other elements of the rail assembly.



### VOC, ODP, HEALTH AND SAFETY

Decidamp RTD Clip is non-toxic and safe to handle by methods prescribed in Safety Data Sheet. No Ozone depleting substances are used during the manufacture of Decidamp RTD Clip.

### SPECIFICATIONS

Colour	Stainless Steel
Available	AS60 Track
	Other track profiles available

## features

- Compatible with Decidamp RTD AS60-8500 dampers
- Resistant to environmental corrosion
- Easily installed, reducing down time during commissioning of new rail tracks or during maintenance
- Minimal maintenance requirement after installation, long life once fitted
- Does not interfere with other elements of the rail assembly
- Suitable for use with AS60 rail tracks



# INSTALLATION GUIDE



## DECIDAMP® RTD

This installation guide provides recommendations to maximize the service life of Decidamp RTD for rail track applications.

### KEY INSTALLATION REQUIREMENTS

- Ensure rail track surface is clean, free of dirt or other obvious contaminants before installing.
- Decidamp RTD to be installed with contact paste or adhesive. Variants available for use without contact paste.
- If contact paste / adhesive is specified then we recommend Fix 8 Adhesive is used.
- Rail should be free of large quantities of moisture (eg. rain water).
- Installation can be done over rust.

### TRACK IDENTIFICATION MARKINGS

- Consideration should be made for rail identification markings.
- Damper can be removed to reveal identification marking.
- If completely obscured, a method of identifying the markings location is recommended.
- If adhesive contact paste is used, preventing removal of rail damper, rail identification should be transcribed to plaque, and attached to external face of Decidamp RTD.

### INSTALL PREPARATION

- Each Unit installed shall consist of:
  - 4 Decidamp RTD dampers
  - 8 Decidamp RTD Clips
  - Fix 8 adhesive if specified by contractor at time of purchase
- Each damper to be installed at mid-point between sleepers

### PRIOR TO INSTALLATION

- Materials should be stored adequately as per TDS/SDS.
- Dampers should not be exposed directly to weather or outdoor elements prior to installation, as best practice.
- Contact paste should not be allowed to freeze.

### APPLICATION OF DECIDAMP RTD CLIP WILL REQUIRE

- A dead blow hammer.

### IF APPLYING CONTACT PASTE YOU WILL REQUIRE

- Caulking gun.
- Each damper will require 25 grams of contact paste.



*Pyrotek offers rail dampers to reduce radiating noise from railway rolling stock.*

### AREA OF APPLICATION

- For use on rail supported on sleepers, slab track or non-embedded vignole rail.
- Maximizes benefit of low or medium resilient rail pads and fasteners.
- Reduces structure borne noise generated by rail track, and allows complete rail system design to reduce ground-borne noise, vibration in track & sleepers.
- Avoid the application where any of the following obstructions are:
  - Welding joints
  - Cable connection points
  - Other rail mounted fixtures
- Reduces rail fatigue
- Minimise track maintenance



## DAMPER INSTALLATION

- When specified, apply contact paste (Fix8), to circular glue cavity of Decidamp RTD.
  - Contact paste should be applied at temperatures above 4°C and below 40°C. Installation outside of this range is not recommended or warranted.
- Place damper in location where installation required, a damper should be installed symmetrically on each side of the rail, on both rails.
  - At mid-point between sleepers. For example, at 700 mm centered spacing.
  - Perform visual inspection to ensure blocks are correctly fitted to the curvature of the rail profile.
  - Rail shall remain fixed by fasteners during installation.
- Place clips in configuration shown
  - Clip should be at least 20 mm from edge of the Decidamp RTD damper.
- Use installation tool, dead blow hammer or mallet to impact lower end of clip, so that clips fasteners hook to the foot on the other side of the rail track. See picture 2
- If specified, apply contact paste into adhesive recess of each end of damper.
- Visually inspect that clip is correctly installed and that damper is firmly in place. Proceed with next damper.

## REMOVAL OF DAMPER

- Removing the damper without the use of contact paste can be easily done by using a lever such as a pinch bar.
- Clips must be replaced once removed. Dampers can be reused if removed in good condition.
- If contact paste and clips were used during installation, clips can be removed as above, and damper should be removed using a mallet and chisel. Dampers and clips cannot be reused if installed with contact paste.

## WORKING HEALTH AND SAFETY

- Suitable personal protection equipment (PPE) should be used during all methods of installation and maintenance. Refer to the materials safety datasheet to determine the appropriate PPE to be used.
- Suitable care must be taken to avoid damage to adjacent materials and finished surfaces.

Please contact Pyrotek® for further information or detailed advice on your specific application.



1. Decidamp RTD Clip

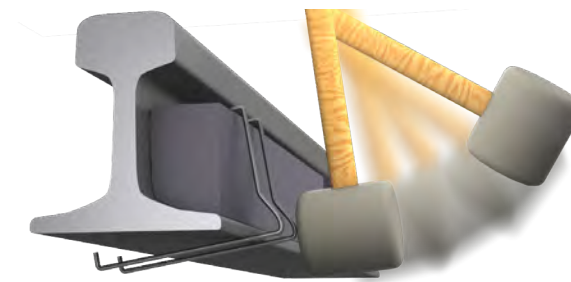

2a. Installing Decidamp RTD Clips



2b. Installing Decidamp RTD Clips

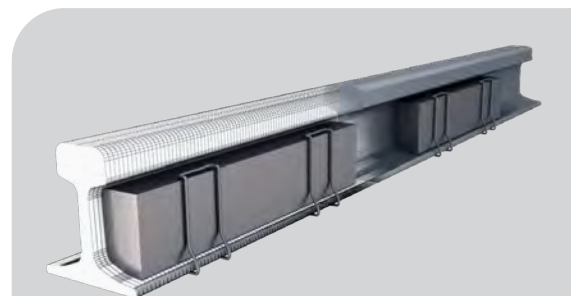

3. Render of complete Decidamp RTD system

# HANDLING GUIDE



## DECIDAMP RTD SHIPPING AND HANDLING GUIDE

*This guide is designed to give advice and direction for the general shipping and storage of Decidamp RTD rail dampers. This is a general guide only and all normal health and safety procedures should be followed, and site conditions considered to complete a thorough risk assessment.*

***The Recipient agrees to strictly follow and observe all manufacturer instructions and a failure to strictly store or handle the goods as directed may lead to personal injury, death and/or property damage, including damage to the goods. Pyrotek disclaims and excludes all liability for claims caused by the Recipient not strictly following the manufacturer's recommended storage and handling procedures.***

**\*\*BEFORE HANDLING OR PERFORMING LIFTING OPERATIONS PLEASE BE AWARE THAT DECIDAMP RTD IS A DURABLE PRODUCT, BUT CARE SHOULD BE TAKEN AS TO MINIMIZE THE OCCURRENCE OF AND PREVENT DAMAGE AND INJURY. DECIDAMP RTD DAMPERS ARE HEAVY WEIGHTING NOMINALLY 8.5KG, REQUIRING ADDITIONAL CARE WHEN HANDLING. CARE SHOULD BE TAKEN WHEN HANDLING STAINLESS STEEL FACE PLATE AND CLIPS TO AVOID HAND INJURIES.**



### Shipping and Packing

Decidamp RTD is shipped on wooden pallets, vertically stacked 5 dampers high and wrapped with plastic wrapping.

Standard Decidamp RTD dampers are 400 mm long, and weight 8.5 kg.

Each pallet is 1.2 x 1.2 x 0.5 m (Length x Width x Height).

The weight of each pallet is approx. 1200 – 1500 kg.

These values will vary based upon project specific design and style. Refer to product TDS for more information.



## Handling Palletised Decidamp RTD

1. Pallets are wrapped to prevent dampers falling loose.  
Do not move pallet if wrapping is removed or damaged.
2. Handle with care and avoid impact.
3. Avoid sudden drops when moving via forklift.
4. Avoid bumps when travelling with pallets on forklift.
5. Keep area around forklift clear, suggest:
  - a. 3m exclusion zone. Spotter should remain clear of the forklift, at a safe distance.
6. Move only with forklift or pallet jack.



## Unpacking Decidamp RTD pallets.

1. Pallet should be placed in a safe location prior to unpacking, clear of other Decidamp RTD pallets, visual obstructions, or hazards.
2. Inspect for damaged prior to unpacking.
3. Appropriate PPE to be worn, including steel capped boots and gloves.
4. Consider weight of the product when lifting and handling. Manage fatigue when installing large quantities.

## Storage

1. Do not stack pallets on top of each other or stack anything on top.
2. Protect from any mechanical damage (Bumps or knocks).
3. Make sure pallets are stored on level ground, placed gently down not shunted into place with tines of forklift.
4. Pallets should be covered to prevent moisture ingress to prevent moisture ingress, which would cause damage to strapping & pallets.
5. When covered ensure also adequate ventilation of the covering to prevent sweating and condensation build up.

# SERVICE LIFE





**MAHAFFEY ASSOCIATES PTY LTD** (ABN 90 001 629 036)  
Incorporating BEMAC Laboratories  
Unit 9 / 108-110 Percival Road (P O Box 2162), Smithfield NSW 2164  
Ph (02) 9756 4003 Fax (02) 9757 4228 Email mahaffey@mahaffey.com.au

*BAS/20/L01/10929*

6 October 2020

Pyrotek Pty. Ltd.  
147 Magowar Road  
**GIRRAWEE NSW 2145**

Attention: Benjamin Dowdell

Dear Sir,

**Re: Service life Assessment of Rail Damper - Decidamp RTD**

This report presents an assessment of the service life of Decidamp RTD in a tunnel environment. Decidamp RTD is an engineered polyurethane block which is clamped to rail track using metal clips.

**1. Product Description**

It is described by the manufacture as a noise reducing tuned mass rail track damper. Decidamp RTD is a high-performance engineered polymer composite designed to effectively reduce structure borne noise generated during contact between the track and railway rolling stock wheels - also known as wheel/rail interface.

Decidamp RTD dampers are attached to the sides of the rail using specially designed brackets. They are designed to be installed and fitted to most rail tracks and can be modified to meet customer noise requirements.

Decidamp RTD is polyurethane with carbon black filler cast or moulded around a steel mass used as the “spring” and “damper” to provide “tuned mass damping” effect. The mass, size, and shapes are designed for a given application.



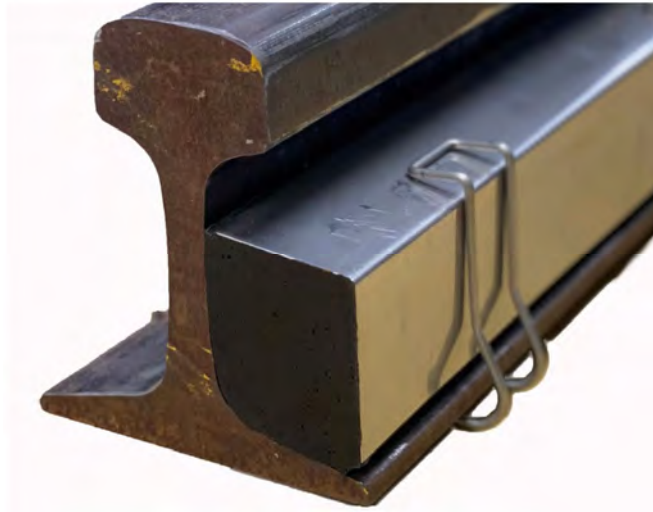

Figure 1: Decidamp RTD block attached to the sides of a rail track

## 2. Durability Assessment

Durability is defined as the ability of a material to maintain its required performance over a given time in an exposed environment. The durability of a material is thus dependent on the intended use of the material and its service conditions. The durability assessment of a material is determined by combination of the responses of the product as a whole or the individual parts, insofar as these parts play a significant part in the fulfilment of the required performance.

Due to its remarkable impact and abrasion resistance, parts made from polyurethane elastomers will often outwear rubber, plastic, and metal by margins of 20 to 1. Other important characteristics include extremely high flex life, cut resistance, load bearing capacity and outstanding resistance to weather, ozone, oxygen, and radiation. It performs well from -62°C to 93°C and has excellent resistance to oil, gasoline, and most solvents.

Decidamp RTD is best described as polyurethane with embedded metals within the polyurethane. Therefore, durability is mainly determined by the polyurethane.

Polyurethane was invented in the 1930s by Professor Dr. Otto Bayer (1902-1982). There are various types of polyurethane, which look and feel very different from each other. However, the basic chemistry of each type is essentially the same. Therefore, the durability assessment is based on research of polyurethane products over the years.

### ***Mechanical Properties***

Data available showed tests carried out on polyurethane insulation material after 28 and 33 years in service to assess the following characteristics

- Thermal conductivity
- Compressive strength
- Moisture content
- Dimensional changes and product integrity of the insulation board

The results of these tests are presented in Table 1 and 2.

Table 1: Test results of a 28-year-old polyurethane insulation product

Property	Initially declared characteristics	Measured value after 28 years
<b>Facing: Aluminium multilayer facing on both sides, one side perforated</b>		
<b>Thickness</b>	100 mm	101.08 mm
<b>Moisture content</b>	Not declared	0.05 Vol. %
<b>Compressive strength</b>	150 kPa	208 kPa
<b>Thermal conductivity</b>	0.030 W/(m K)	0.0292 W/(m K) (10°C mean temperature)
<b>Reaction to fire</b>	Class B2 (normally ignitable) in accordance with DIN 4102-1 No flaming droplets / particles	Class B2 (normally ignitable) <sup>4</sup> in accordance with DIN 4102-1 No flaming droplets / particles

Table 2: Test results of a 33-year-old polyurethane insulation product

Property	Initially declared characteristics	Measured value after 33 years
<b>Thickness</b>	60 mm	59.05 mm
<b>Moisture content</b>	Not declared	0.07 Vol. %
<b>Overall density</b>	Not declared	30.7 kg/m <sup>3</sup>
<b>Compressive strength</b>	150 kPa	226 kPa
<b>Thermal conductivity</b>	0.030 W/(m K)	0.0272 W/(m K) (10°C mean temperature)

The tests demonstrated that, after decades in application, these PU insulation boards were fully functional and still reached all originally declared values and performances.

### ***Thermal Resistance***

The effect of temperature on Decidamp RTD in the tunnel environment the product is proposed to be used is insignificant, because polyurethane performs satisfactorily in a wide range of temperature. In general, polyurethane can be used in temperature range of -62°C to 93°C. Above 93°C, the dynamic performance properties become significantly degraded. However, below 93°C, performance degradation endured for several weeks, is completely reversible once the temperature is returned to typical operating temperature.

### ***Ultra-Violet Resistance***

The ultra-violet (UV) resistance and stability of polyurethane depend on the manufacturing process of the product. Polyurethane which is based on aromatic isocyanates will all exhibit various shades of yellowing when exposed to light (including ultraviolet radiation).

The yellowing that can occur in UV exposed polyurethane is a surface effect and has no significant impact on the physical properties of the polyurethane product. The degree of yellowing depends on the intensity of the radiation that the product has been exposed to.

In this application (Decidamp RTD tuned mass damper), the polyurethane is not exposed to significant amounts of UV light, so discoloration should not be an issue. In addition, the polyurethane is black, so discoloration is expected to be minimal.



Figure 2: Metal covered Decidamp RTD

A metal faceplate is proposed to be attached to the product to cover the exposed surfaces of the product. The metal plates would be part of the manufacture process and adhered to the damper (see Fig. 2). Polyurethane bonded easily to other materials, such as many types of metal, composites, and to both reinforced and unreinforced plastics. With correct preparation, the bond strength may exceed the tear strength of the polyurethane. Therefore, delamination of the metal surface cover is not expected.

The metal cover will add protection and durability to the product because, the metal cover would restrict exposure to UV and other environmental impacts.

#### 4. Conclusion

Based available data on the performance of polyurethane in service the Decidamp RTD is expected to provided service life in the proposed application more than 35 years and even more if it is not damage by mechanical stress in the installed locations. To achieve the design life, the requirements of the installation and maintenance manuals from the manufacturer must be followed.

We trust that this information is of assistance; however please do not hesitate to contact me, should you require anything further.

Yours faithfully

MAHAFFEY ASSOCIATES



Ben Sabaa B.Sc. (Hons), M. Eng. Sc., Ph. D.

#### Conditions of Use

This report takes into account the particular requirement of our client. It is not intended and should not be relied upon by any third party and no responsibility is undertaken to any third party.

# 4 | **FIX8 ADHESIVE**



**FIX8** is the recommended adhesive for Reapor® and Viterolite® products.

# FIX8 ADHESIVE

**FIX8** is a high-quality architectural grade structural silicone sealant, that exhibits excellent physical properties. Suitable for typical sealing and structural bonding in glazing applications.

Fix8 displays excellent weatherability and UV resistance curing to a high-performance flexible rubber sealant in weatherproofing and structural applications.



## Specifications

<b>Colour:</b> Light Grey
<b>Packaging:</b> 600 ml foil <b>Adhesive type:</b> Silicone

## Features

- Primerless adhesion on most substrates (except Teflon, PE and PP)
- Excellent UV resistance
- Very good filling capacities
- Excellent stability
- Superior weather resistance

## Surface Preparation

All substrates must be clean and free from laitance, curing compounds, dirt, dust, grease, oil and any other contaminants that may inhibit bond. All substrates should be washed with clean water just prior to the application of the adhesive. Care must be taken in the preparation of concrete tilt panel to ensure all traces of release agents and curing compounds are removed, if in doubt prepare the substrate using a pressure washer to expose the fine aggregates in the matrix of the concrete as this will ensure a clean substrate.

# TECHNICAL DATA SHEET



## FIX8

### structural silicone sealant

Fix8 is a high quality architectural grade single component high modulus structural silicone sealant, neutral cure, that exhibits excellent physical properties. Suitable for typical sealing and structural bonding in glazing applications with metal, aluminium, Corian® most plastics and fibreglass substrates.

Fix8 displays excellent weatherability and UV resistance curing to a high performance flexible rubber sealant in weatherproofing and structural applications. Fix8 is suitable for glass curtain wall construction.

#### SPECIFICATIONS

Colour	Light Grey
Packaging	600 ml foil
Shelf life and storage	12 months from date of production In unopened packaging stored in a cool and dry place at temperatures between 5 °C and 23 °C

#### HEALTH AND SAFETY RECOMMENDATION

Apply the usual industrial hygiene. Wear gloves, safety glasses. Volatile compound released during curing, ensure adequate ventilation.

*Note: The contents contained in this documentation are the result of our experiments and our experience and have been submitted in good faith. Because of the diversity of the materials and substrates and the real number of possible applications which are beyond our control we cannot accept any responsibility for the results obtained. In every case it is recommended to carry out preliminary experiments and compatibility tests.*



### applications

- Sealing and bonding of low movement wall joints and roof constructions
- Suitable for bonding and sealing but not limited to steel, aluminium, stainless, PVC, fiberglass, concrete, composite, glass, timber, mirrors, polystyrene, rubber, PU foam, etc.
- Connection joints in sheet metal fabrication
- Sealing and bonding of coachwork, caravans, buses, automotive, domestic and commercial construction

### features

- Primerless adhesion on most substrates (except Teflon, PE and PP)
- Excellent UV resistance
- Very good filling capacities
- Neutral cure (pH=7)
- Excellent stability
- Superior weather resistance up to 20 years
- Good compatibility with other sealants
- Permanently elastic
- Colour Fast
- Suitable for marine exposure





## MATERIAL PROPERTIES

Base	Silicone
Consistency	Paste
Curing system	Moisture Cure
Skin Formation(*)	30 minutes (23 °C & 50% R.H)
Tack Free Time (*)	3 hours (23 °C & 50% R.H)
Cure Rate (*)	3 mm/24 Hrs
Density	1.34 g/cm <sup>3</sup>
Shrink	3%
Elongation	300%
Hardness (Shore A)	40±5
Tensile Strength	>1.0 Mpa (ISO8339)
Shear Strength	> 1.0 Mpa
Movement Capability	25%

\*Values may vary depending on environmental conditions

## APPLICATION EQUIPMENT

**Method:** Manual or pneumatic caulking gun

**Application temperature:** +4°C to 40°C

**Tooling:** Mild diluted soapy solution before skin formation

## SURFACES

State of Surface: clean, dry, free of dust and grease.

**Priming:** For porous substrates (floors, walls or ceilings) Fixseal 1060 may be applied. Polypropylene; Primer PR20.

Nonporous substrates (floors, walls or ceilings) may be cleaned with Methylated Spirits or alcohol cleaner we recommend compatibility tests.

**Remarks:** Fix8 can not be overpainted. Fix8 may discolour with age under certain conditions. Fix8 is chemically neutral (pH=7).

Fix8 can be applied to a wide variety of substrates. Due to the fact that the specific properties of substrates will differ from manufacturer to manufacturer we strongly recommend compatibility tests.

# CASE STUDY





# PYROTEK PART OF LARGEST ROLLING-STOCK PROJECT IN WA HISTORY

CASE STUDY

## BACKGROUND

Pyrotek has reached another project milestone supplying the transport industry. Our acoustic and thermal insulation materials specially designed and engineered for rolling stock are part of the METRONET Railcar project in Perth, Western Australia (WA). The project will bring 246 new electric and 6 new diesel railcars over the next 8 years. Perth's population is expected to grow from 2.02 million in 2017 to 3.5 million by 2050 (Perth and Peel @ 3.5 million) so the METRONET Railcar Program, delivering additional trains to service the expanding public transport network, is crucial to the growth management and meeting the city's future infrastructure needs. Pyrotek products installed in the trains will help to substantially reduce noise levels, improving the safety and comfort to approximately 1,200 passengers at any given time.

The project is the largest ever railcar contract in the history of Western Australia and has been awarded by the Public Transport Authority of Western Australia (PTA) to global leader in rolling stock manufacture – Alstom. The METRONET Railcar Program required Alstom to provide 50% local content for the manufacturing of the new railcars, aiming to revitalise the train industry in Western Australia. For Pyrotek, a global manufacturer with locations worldwide including Australia, this was an easy procurement factor to work with. With the shells of the trains being built in India, bogies made in WA and AC units in Germany, the new C-Series trains are going to be assembled and equipped with Pyrotek solutions at Bellevue in Western Australia, a purpose-built new facility and one of the most technologically advanced train manufacturing and maintenance sites in Australia.



Interior of the C-series trains for Perth, WA.

*Acoustically exceptional & comfortable train experience thanks to Pyrotek acoustic flooring panels & specially engineered noise absorbers for walls and ceilings.*

## UNDERSTANDING THE PROJECT

Alstom procurement team approached Pyrotek Australia based on their positive relationship with our facility and team in India - Alstom's main manufacturing plant location. Technical discussions regarding the acoustic and thermal insulation materials to be engineered and used specifically for this project started in May 2020, the initial request being phenolic-faced plywood flooring with premium acoustic performance. Quickly realizing Pyrotek had a lot more to offer, Alstom brought additional materials into the selection and established Pyrotek a preferred supplier of insulation.

The main project objective for Pyrotek was to maximize Western Australia content for the insulation supplied, which was quite difficult keeping in mind that most of the raw materials had to come from overseas. One of the most challenging tasks was to find

*Thanks to Pyrotek's advanced insulation materials, the C-series trains for the METRONET Railcar Program will boast higher levels of acoustic & thermal comfort, improved energy efficiency, and an uncompromised level of safety.*



*The next generation of C-series trains for Perth's growing rail network with premium acoustic & thermal comfort and passenger safety.*





the right supplier of the plywood panels for the flooring system as very few places around the world supply plywood in sheets large enough for this project. Pyrotek had even gone the extra mile and moved its facility in WA to a much larger one to be able to satisfy the demand, supply the products required on time, and further increase WA content.

## DEVELOPING A UNIQUE SOLUTION

Pyrotek R&D Centre played a crucial role in the long list of external and internal testing carried out to make sure the flooring panels are suited for purpose. Dynamic loading was one of the most extensive tests carried out with the assistance of the University of Technology in Sydney and required 2 months of continuous testing to complete. Internal testing was carried out on the installation method of insulation in the ceiling cavity as Pyrotek proposed a new, more time-efficient way. This, being a first for Alstom, required the solution to be thoroughly tested.

Pyrotek Engineering Centre in Australia contributed immensely as numerous 2D drawings from CAD data had to be prepared, taking up a substantial amount of engineering time.

Thinner veneer layers in cross pattern give Subdue® TR its superior strength when compared to plywoods commonly used, as well as increased internal damping of the panel. Phenol-formaldehyde resin between the layers gives it resistance against environment, weather conditions, hot/cold water and steam.

The first supply of the parts to the C-Series trains took place in May 2021. Materials supplied include specially engineered acoustic flooring panels - Subdue® TR, together with additional sound and thermal insulation materials for ceiling and wall cavities. Subdue® TR are multi-layered, internally damped noise barrier floor panels constructed from layers of birch veneers. Combined with a premium acoustic barrier, these create Subdue® TR Plus for an even higher level of noise reduction. Both work by reflecting, absorbing and damping the vibration and transmission of sound through the floors, reducing the noise generated from the train underbody and track noise. Lighter Subdue TR is installed in the middle section of the carriages in order to prevent from adding unnecessary weight to the overall weight of the car. Subdue TR Plus, which also incorporates the acoustic barrier in the floor panel, is installed in sections over the bogies to reduce track noise transmitting into the carriage from the wheels.

Additional acoustic and thermal insulation materials were part of the complete solution. Sorberwool, lightweight and fire resistant on its own, was used in the flooring cavities and around the door

*C-Series METRONET railcars include Pyrotek acoustic flooring panels.*

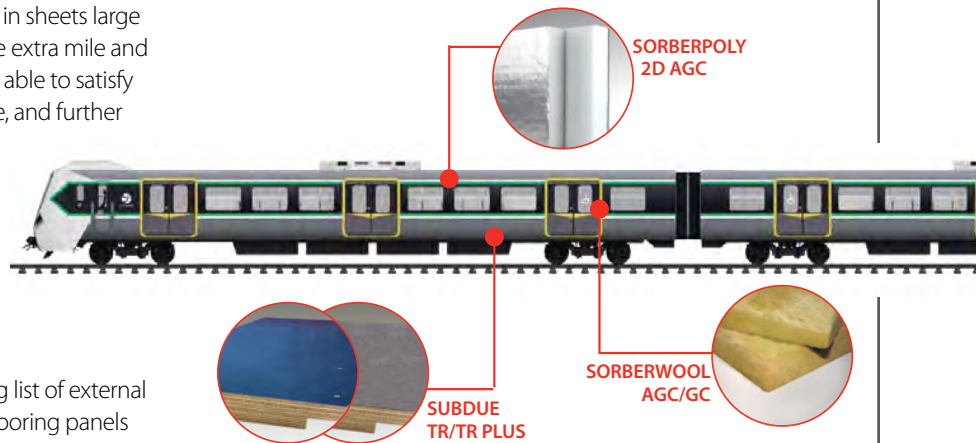

perimeter. Sorberpoly 2D, consisting of 2D non-woven, ultrafine polyester fibres, was installed in the carriage walls and ceilings. Both products are designed to offer excellent acoustic and thermal insulation properties and are faced with a durable, flame retardant glass cloth (GC) or aluminium foil-covered glass cloth (AGC) to provide extra protection to passengers in case of fire.

Pyrotek understand the responsibility that goes hand in hand with a "preferred supplier" label, making sure every delivery arrives on time, with proper packaging and minimal installation requirements. When nearing the supply stage and final delivery, Pyrotek went the extra mile to assure on-time delivery for the METRONET project, arranging a number of raw materials to be airfreighted in order to meet the timelines required for the project. Multiple additional components had to be developed as part of the overall supply package, right down to the delivery method of the flooring panels to enable easy handling and installation in the carriages. This was further enhanced by providing all materials precut and in kit form.

## RESULTS

Materials specified for installation in rail carriages must comply to strict fire standards. The prerequisites in terms of the fire performance for this project were HL2 R1 and R10 according to EN45545-2. Pyrotek have exceeded these requirements with all supplied materials complying to the highest possible fire requirement being HL3 for both R1 and R10 categories.

The C-series trains for the METRONET Railcar Program will boast higher levels of acoustic and thermal comfort and improved energy efficiency together with an uncompromised level of safety - all delivered thanks to Pyrotek's advanced & proven insulation materials, in full compliance with or even exceeding rail and fire standards. The first C-series railcars are expected to go into service in 2022 with passenger comfort and safety never better.



Please refer to our website [pyroteknc.com](http://pyroteknc.com) for the latest information



*The Bellevue Railcar Manufacturing and Assembly Facility is where Pyrotek acoustic and thermal insulation is being installed in the carriages. Once assembly on the new C-series railcars is over, the facility will be used in the future for maintenance of the Public Transport authority's railcar fleets.*

"The Bellevue plant is where Western Australia's biggest ever order of railcars will be built, tested and maintained for decades to come."

-Rita Saffioti, Transport Minister

*New Metronet Railcar Program manufacturing and assembly facility in Western Australia.*



## ROOM TO GROW

Now that Alstom completed its acquisition of Bombardier Transportation early 2021, it has gained access to the Australian Bombardier production facility where the majority of Victoria city tram supply originates from. This will strengthen Alstom's position as leading supplier for Australia's rail and infrastructure market, with more opportunities for Pyrotek-Alstom cooperation.



This project, although largely supplied from Australia, has involved other Pyrotek facilities around the world, such as Pyrotek India and Czech Republic, validating Pyrotek's status as a truly global supplier.



*Pyrotek® is a well-trusted name for market-leading acoustic and thermal insulation solutions with over 40 years of noise control experience, world-class manufacturing technologies and advanced R&D expertise. We refine existing products and create new materials to meet the unique needs of our customers, worldwide.*

For more information on acoustic and thermal solutions for your project, please contact us or visit [www.pyroteknc.com](http://www.pyroteknc.com).

## DID YOU KNOW?



All materials supplied by Pyrotek for the METRONET Railcar Project are safe to use - for installers, for passengers, for the natural environment. They are non-toxic and no ozone depleting substances are used during their manufacture.

Sorberpoly 2D is made from 80% recycled materials - manufactured from 100% polyester fibre, it will not irritate skin when handled, unlike traditional fibreglass or mineral wool alternatives.

Sorberwool, with AGC and GC encapsulating all the loose fibres, is a material much more operator-friendly, both to handle and install, compared to standard rockwool insulation. Pyrotek supplied Sorberwool as pre-manufactured panels with edge wrapping, preventing loose fibres not only during the installation process but also over its lifespan.

Pyrotek endorses forest sustainability and the preservation of natural environment. We procure highest quality materials from suppliers who hold FSC Certification (Forest Stewardship Council) and PEFC (Programme for the Endorsement of Forestry Certification) amongst other certification programmes. Subdue TR grade achieves E1 class when tested to EN13986 and A class according to standard EN1084.



SOURCES & IMAGE CREDITS:

<https://www.metronet.wa.gov.au/projects/wa-railcar-program#overview>

<https://www.alstom.com/press-releases-news/2019/12/alstom-locally-manufacture-and-maintain-ptas-c-series-trains-perth>

<https://www.globenewswire.com/news-release/2019/12/10/1958309/0/en/ALSTOM-SA-Largest-ever-train-procurement-for-Western-Australia.html>

<https://www.wa.gov.au/government/publications/perth-and-peel-35-million-frameworks>

# Pyrotek



# REAPOR ALONG GUNNEDAH RAIL LINE (NSW AUSTRALIA)

## BACKGROUND

The Gunnedah coal basin located in the Upper Hunter Valley of NSW Australia, provides a significant volume of high quality export coal. During 2012 it became apparent that due to system-wide congestion issues it would not be possible for the coal chain to handle the conditional volumes of coal contracted by producers. The contracted volumes by the Hunter Valley Coal Chain Coordinator (HVCCC) in conjunction with the Australian Rail Track Corporation is in excess of 150mtpa (million tons per annum) with forecasts to reach 206mtpa by 2019. Capacity constraints within the rail corridor have been a major focus with reduced rail speed through existing rural townships being a contributing factor to efficiencies.



Reapor installed on Noise Wall 1 to protect the Gunnedah community

## DEVELOPING A SOLUTION

Increasing the rail speed and frequency of movements produces greater noise emissions effecting townships. This resulted in a requirement for a high performance noise mitigation strategy, incorporating Noise barrier walls. Hebel has been successfully adopted throughout the Upper Hunter freight corridor to reduce noise. The design, supply and installation of a Hebel noise wall incorporating Reapor within the corridor was undertaken, with aesthetics of the community being incorporated. Reapor was considered the best solution for increasing the acoustic absorption function of the walls so was affixed to the rail line facing side of the walls.



Installing Reapor on site using flexible, thixotropic adhesive.

## RESULTS

Noise barrier walls were built along the Gunnedah Rail Corridor in order to minimise the impact of noise pollution from trains entering and exiting Gunnedah. Reapor acoustic panels were installed at Noise Wall 1 and 2 adjacent to the corridor. Feature panels were also incorporated into Noise Wall 3 and 4.

The installation of Reapor over Hebel was a unique solution to address high frequency noise emissions. This high performance composite wall system meant the height of the wall could be reduced, improving the aesthetics of the area. Installing Reapor was extremely fast, as it is lightweight and easy to handle. The completed project was delivered within 14 days of commencement.



The decorative front of the Noise barrier wall (Reapor applied to reverse side)





# SUCCESS AT NORTHWEST

## BACKGROUND

Sydney Metro Northwest is the first stage of the new metro system in Sydney, Australia. It is Australia's biggest public transport project.

Northwest Rapid Transit (NRT) has been awarded the Operations, Trains and Systems contract for this project. The first stage of the project for Pyrotek is estimated at \$8.3 million (AUD). It runs from Rouse Hill to Epping and includes a 4 km elevated Skytrain, a 270-metre cable-stayed bridge and twin 15 km tunnels. This is also Australia's first autonomous (driverless) rail system.

NRT contacted Pyrotek to source acoustic absorbing materials for the rail tunnel and viaduct. The designers of the tunnel and acoustic consultants had specified acoustic absorbers on both walls of the tunnel as well as in the four-foot section (between the tracks). This was done to give maximum passenger comfort and the aim was to provide very low noise levels for passengers.

As well as being excellent noise absorbers, any materials selected also needed to be fire safe. This means that non-combustibility of the materials is important as well as making sure that if the material does get hot that it does not emit smoke or toxic fumes. Many traditional absorbers such as foams and polyesters do not meet the required standards for rail tunnels so alternate materials were needed. Also, the four-foot section was designated as an emergency exit pathway so any materials in this area also need to be "trafficable", meaning that they can be walked on by pedestrians.

## DEVELOPING A SOLUTION

When first approached by NRT, Pyrotek proposed two different materials. One for the tunnel floor (T1) and another for the tunnel walls (T2).

The product proposed for the walls (T2) was Reapor. This lightweight, a high absorbing material is fire safe and is produced by bonding together millions of expanded recycled glass beads. The contract for this product was awarded to Pyrotek and the product supplied from April – December 2017. The material was imported from Europe by Pyrotek and stored in Australia until required for the project. In addition to this, Pyrotek also cut to shape the majority of the product in Australia to meet NRT's requirement.

The solution for the T1 area on the tunnel floor (four foot) was less straightforward. Pyrotek proposed several materials for this application but all were rejected. The main reason for this was the strength of the product. The requirement that the product is "trafficable" was one not encountered previously, so Pyrotek's technical team stepped in and from their archives of technical knowledge developed a material with the correct properties. This material has all excellent fire safe characteristics of Reapor with the additional advantage of being very strong. With some clever use of Pyrotek's reverberation room in Sydney, the material was



Viterolite® 900 in-between the rail track with Reapor on the wall

also tuned to give the optimum acoustic absorption at individual frequency bands. This allows the material to more specifically reduce the noise of the moving train. The T1 product is called Viterolite® 900.

Viterolite® 900 was presented to NRT and approved for use on the project. The contract was awarded to Pyrotek with supply from September 2017-June 2018. This allowed a 9-month manufacturing window for the product.

## RESULTS

Having received the contract, Pyrotek leased a site in Sydney to manufacture the product and designed the plant and equipment to manufacture this large volume of panels.

In July 2017, it became clear that the original delivery schedule no longer met NRT's programme. Pyrotek was requested to accelerate the project and complete deliveries by the end of December 2017. This has been achieved and required the casting of over 100 tonnes of material each day working 24/7.

*"Pyrotek has been a flexible and committed partner making sure we have received the acoustic materials for the Sydney Metro Northwest project on time. Being local and able to change plans as needed has been invaluable to the project and has helped with the planning of logistics and installation. Their ability to meet the revised delivery programme for the T1 panels has been critical to NRT completing this project on time."*

-Simon Tibbet, NRT Area Manager



Viterolite® 900 custom design for the NRT project



# PROJECT PHOTOS





# LOCALLY AND INTERNATIONALLY PROVEN IN ROAD & RAIL SHAFTS AND TUNNELS



Due to the necessary noise protection measures, the tunnel in Dordtsche Kil plays a cutting edge role. The tunnel's walls were fitted with approximately 5,250 square meters of REAPOR.

Brisbane North West Road bypass  
tunnel ventilation shafts









pyroteknc.com

PYROTEK  
WORLDWIDE LOCATIONS

AUSTRALIA

CANADA

CHINA

CZECH REPUBLIC

HONG KONG

INDIA

INDONESIA

JAPAN

KOREA

MALAYSIA

SINGAPORE

NEW ZEALAND

TAIWAN

THAILAND

TURKEY

UNITED ARAB EMIRATES

UNITED KINGDOM

UNITED STATES OF AMERICA

VIETNAM

CONTACT DETAILS

for further information please visit our website at [pyroteknc.com](http://pyroteknc.com)

Pyrotek endorse forest sustainability and the preservation of natural environment. We procure the highest quality materials from suppliers who hold FSC (Forest Stewardship Council) Certification and PEFC (Programme for the Endorsement of Forestry Certification) amongst other certification programmes.

Caveats: Specifications are subject to change without notice. The data in this document are typical of average values based on tests by independent laboratories or by the manufacturer and are indicative only. Materials must be tested under intended service conditions to determine their suitability for purpose. The conclusions drawn from acoustic test results are as interpreted by qualified independent testing authorities. Nothing here releases the purchaser/user from responsibility to determine the suitability of the product for their project needs. Always seek the opinion of your acoustic or mechanical engineer on data presented by the manufacturer. Due to the wide variety of individual projects, Pyrotek is not responsible for differing outcomes from using their products. Pyrotek disclaims any liability for damages or consequential loss as a result of reliance solely on the information presented. No warranty is made that the use of this information or of the products, processes or equipment to which this Information Page refers will not infringe any third party's patents or rights. **DISCLAIMER:** This document is covered by Pyrotek standard Disclaimer, Warranty and © Copyright clauses. See [pyroteknc.com/disclaimer](http://pyroteknc.com/disclaimer).